

FAVORIT

FAVORIT hardware programme

- For PVC window elements
- For timber 12 mm window elements
- For square constructions

Window systems

Door systems

Comfort systems

FAVORIT

Installation instructions



1-sash square tilt-turn

timber 12 mm

without security

fixed handle position

Hinge side Si-line

surface TS

backset 15 mm

5

Hardware set configuration	
General	Locking-points distance 1000; vertical tilt point
Stay side	one-piece stay
Locking side	sash lift arm + mishandl.dev.
Hinge side	corner drive BS 2V
Hinge side turning points	loose filling pc I pre-mounted

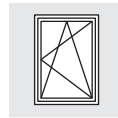

5

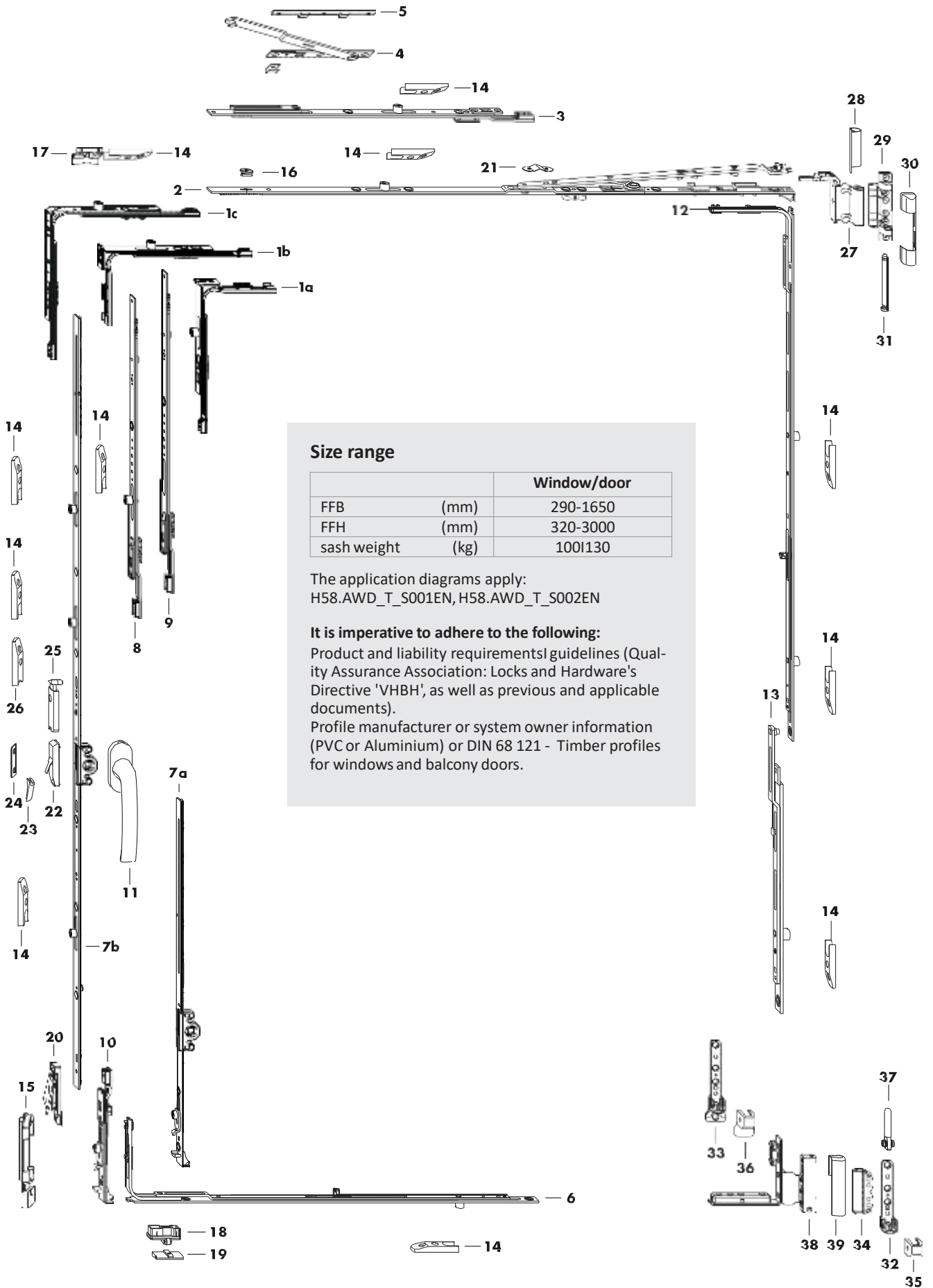

Size range

		Window/door
FFB	(mm)	290-1650
FFH	(mm)	320-3000
sash weight	(kg)	100 130

The application diagrams apply:
H58.AWD_T_S001EN, H58.AWD_T_S002EN

It is imperative to adhere to the following:
Product and liability requirements guidelines (Quality Assurance Association: Locks and Hardware's Directive 'VHBH', as well as previous and applicable documents).
Profile manufacturer or system owner information (PVC or Aluminium) or DIN 68 121 - Timber profiles for windows and balcony doors.



List of fittings
1-sash square tilt-turn
H12 GK Hinge side Si-line

FAVORIT
without security

Pos.	Description	Part number	QTY	FFB	FFH	Dimension G	Number of frame parts / Pos.	
							14	15
1a	corn.drive narrow VSO ..	FEUL0520- ...	1	290- 410	431-3000		1	
1b	corn.drive narrow VSO ..	FEUL0520- ...	1	411- 800	320- 430		1	
1c	corn.drive VSO ..	FEUL0230- ...	1	411- 1650	431- 3000		1	
2	stay 7 sz 30	707302	1	290- 620				
	stay 7 sz 35 MV	707319		621- 800				
	stay 7 sz 50 MV	707326		801- 1030				
	stay 7 sz 55 MV	707333		1031- 1260			1	
	stay 7 sz 50 MV	707326		1261- 1490			1	
	stay 7 sz 55 MV	707333		1491- 1650			1	
3	linkage SIZ FAV 1V	FZOK0100- ...	1	1261- 1650			1	
4	additional stay	Ref. PDB, TSZS	1	1261- 1650				
5	packer Z	Ref. PDB, FRUP01	1	1261- 1650				
6	corn.drive VSU BS sz 50 1V ..	FEUL2070- ...	1	1031- 1260			1	
	corn.drive VSU BS sz 70 1V ..	FEUL2080- ...		1261- 1490			1	
	corn.drive VSU BS sz 90 1V ..	FEUL2090- ...		1491- 1650			1	
7a	gear 15 FAV sz 30IG180	FGKK4010- ...	1	411- 800	320- 430	180		1
	gear 15 FAV sz 30IG180	FGKK4010- ...			431- 600	180		1
7b	gear 15 FAV sz 60IG300	FGKK4030- ...	1		601- 800	300		
	gear 15 FAV sz 80IG400 1V	FGKK4050- ...			801- 1000	400		
	gear 15 FAV sz 100IG500 1V	FGKK4060- ...			1001- 1200	500	1	
	gear 15 FAV sz 120IG600 1V	FGKK4070- ...			1201- 1400	600	1	
	gear 15 FAV sz 140IG700 2V	FGKK4200- ...			1401- 1600	700	1	
	gear 15 FAV sz 160IG700 2V 70	FGKK4090- ...			1601- 1800	700	1	
	gear 15 FAV sz 180IG1000 2V	FGKK4220- ...			1801- 2000	1000	2	
	gear 15 FAV sz 200IG1000 3V	FGKK4230- ...			2001- 3000	1000	3	
8	linkage FAV sz 200 A0767	FZSZ0120- ...	1		2201- 2400			
	linkage FAV sz 400 1V	FZSZ0110- ...			2401- 3000		1	
9	linkage FAV sz 200 A0767	FZSZ0120- ...	1		2601- 2800			
	linkage FAV sz 400 A0767	FZSZ0130- ...			2801- 3000			
10	tilt lock element FAVIFH	FEKB1010- ...	1		601- 3000			1
11	handle Globe	Ref.access. ZHGS	1		320- 3000			
12	corn.drive VSU BS sz 50 1V ..	FEUL2070- ...	1		1001- 1200		1	
	corn.drive VSU BS sz 70 1V ..	FEUL2080- ...			1201- 1600		1	
	corn.drive VSU BS sz 90 1V ..	FEUL2090- ...			1601- 2000		1	
	corn.drive BS sz 130 2V ..	FEUL2630- ...			2001- 3000		2	
13	MV extension sz 60	700952	1		2401- 3000		1	
14	striker plate 56	Ref. PDB, FRSB						
15	tilt striker plate FHA	Ref. PDB, TRKV						
on request								
16	location piece ..	702543	1					
17	frame part SP-S	Ref. PDB, FRZL01	1					
18	sash lift .. A2000	TFFH0010- ...	1		320- 600			
19	run-up FHITIP	Ref. PDB, TRAL	1		320- 600			
20	sash lift KRB .. rh.	TFFH0151- ...	1		601- 3000			
	sash lift KRB .. lh.	TFFH0152- ...			601- 3000			
21	tilt restrictor ..	805701	1		320- 800			
22	mishandling device FAV.	FFBS0110- ...	1					
23	pressure piece	Ref. PDB, TFFD	1					
24	stop	Ref. PDB, FRZF01	1					
25	snapper switchable rh.	TFST0011- ...	1		1801- 3000			
	snapper switchable lh.	TFST0012- ...			1801- 3000			
26	frame part snapper	Ref. PDB, TRST	1		1801- 3000			

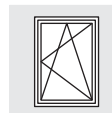

Pos.	Description	Hinge side turning points			required as per sash weight	
		surface TS	Part number		100 kg	130 kg
			RAL9016	RAL8022		
27	stay hinge	Ref. PDB, FBWB			1	1
28	cover cap W timber		FKWB0020-004 ...	FKWB0020-012 ...	1	1
29	top hinge S	Ref. PDB, FBSL02			1	1
30	cover cap S		FKSL0010-004 ...	FKSL0010-012 ...	1	1
31	top hinge pin diam.6	FBSB0010-1 ...			1	1
32	bottom hinge	Ref. PDB, FBEL01			1	
33	bottom hinge S	Ref. PDB, FBEL02				1
34	filling piece H timber	Ref. PDB, FBFS			1	1
35	cover cap EL U		FKEU0010-004 ...	FKEU0010-012 ...	1	
36	cover cap EL-S U		FKEL0010-004 ...	FKEL0010-012 ...		1
37	bottom hinge pin diam.6	TBLB0010-1 ...			1	1
38	reb.cor.hinge	Ref. PDB, TBFE81			1	1
39	cover cap FEB rh.		TKFE7011-004 ...	TKFE7011-012 ...	1	1
	cover cap FEB lh.		TKFE7012-004 ...	TKFE7012-012 ...	1	1

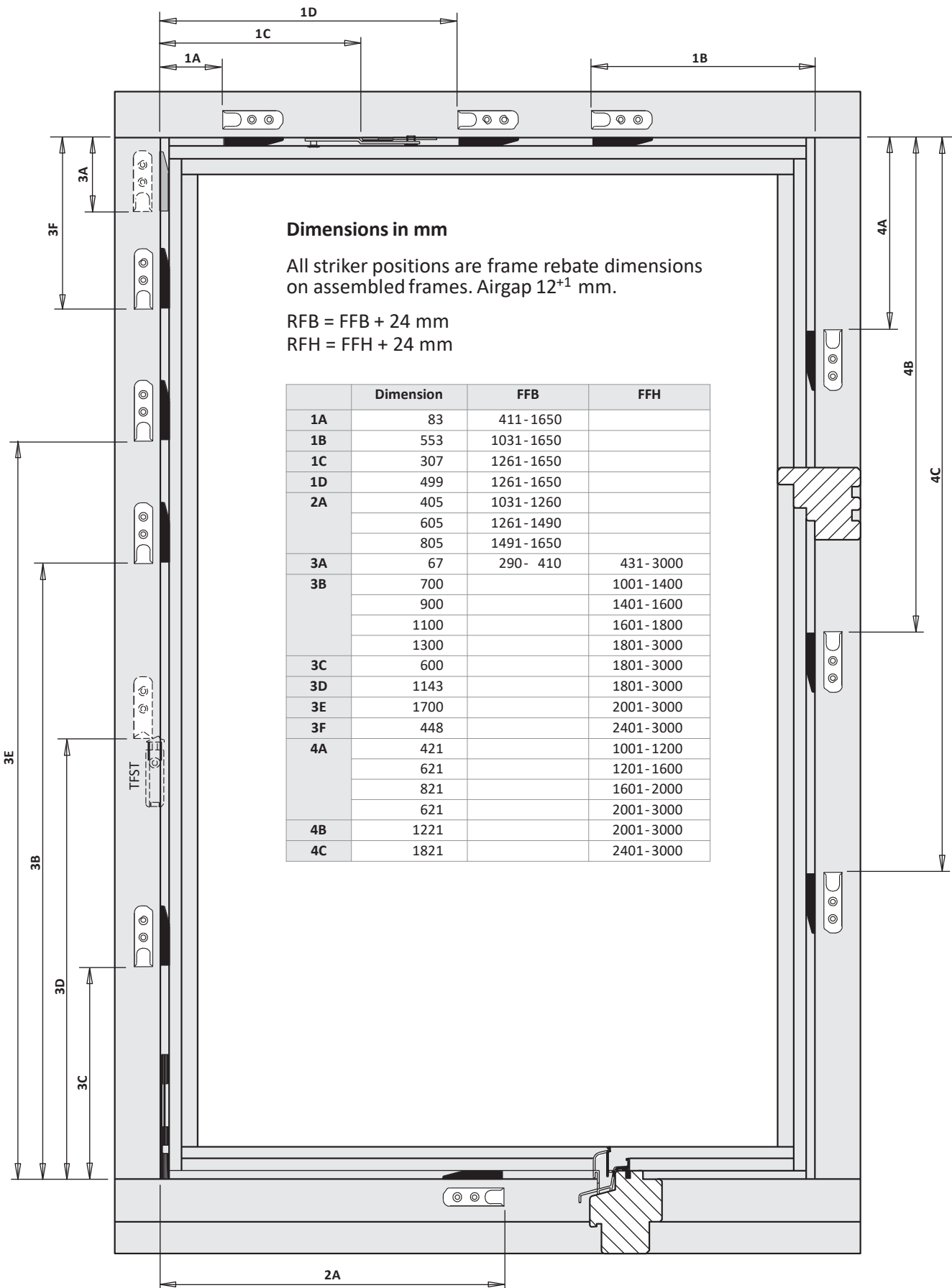

FAVORIT

Installation instructions

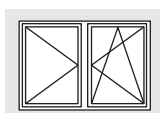

without
security

5

2-sash square tilt-turn turn shoot bolt

timber 12 mm

without security

fixed handle position

Hinge side Si-line

surface TS

backset 15 mm

Hardware set configuration	
General	Locking-points distance 1000; vertical tilt point
Stay side	one-piece stay
Bottom	loose sash lift
Locking side	mishandl. device on gear
Hinge side	corner drive BS 2V
Hinge side turning points	loose filling pc I pre-mounted

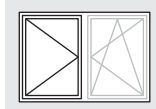

5

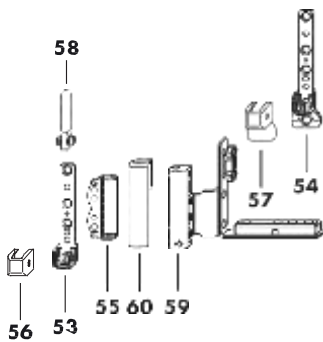
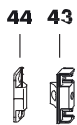
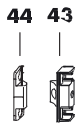
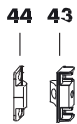
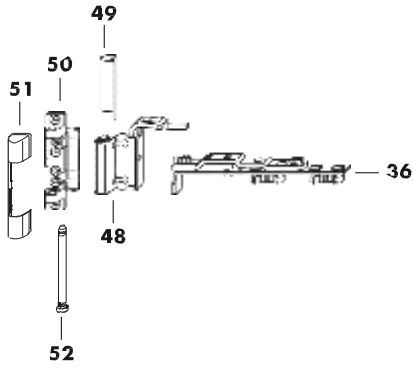

Size range

		Window/door
FFB	(mm)	290-800
FFH	(mm)	365-3000
sash weight	(kg)	100 130

The application diagrams apply:
H58.AWD_T_S001EN, H58.AWD_T_S002EN

It is imperative to adhere to the following:

Product and liability requirements| guidelines (Quality Assurance Association: Locks and Hardware's Directive 'VHBH', as well as previous and applicable documents).

Profile manufacturer or system owner information (PVC or Aluminium) or DIN 68 121 - Timber profiles for windows and balcony doors.

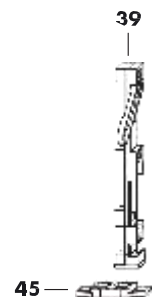
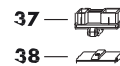

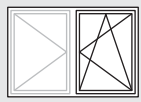

hardware layout main sash

2-sash square tilt-turn turn shoot bolt

H12 GK Hinge side Si-line

FAVORIT
without security

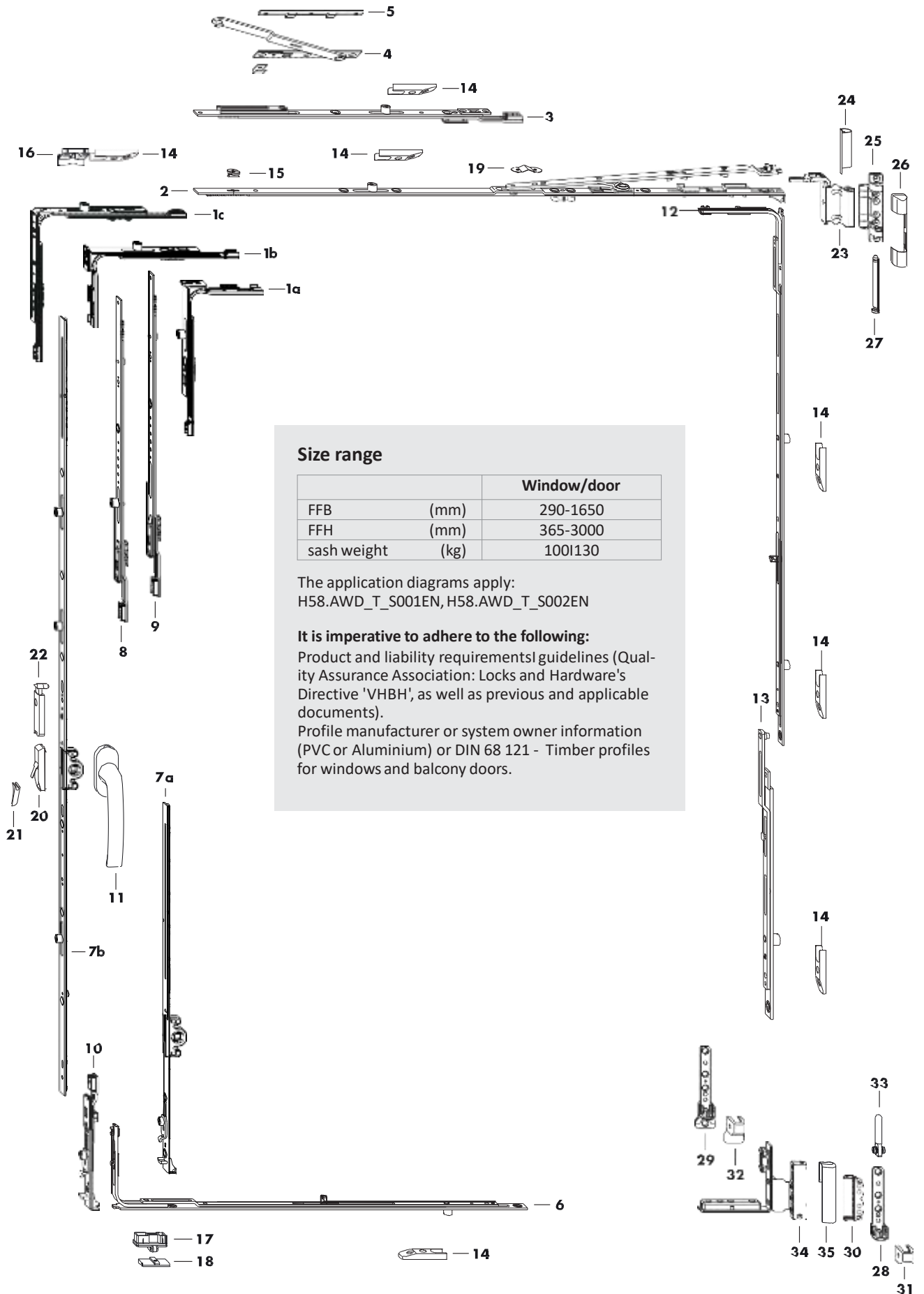

Size range

		Window/door
FFB	(mm)	290-1650
FFH	(mm)	365-3000
sash weight	(kg)	100 130

The application diagrams apply:
H58.AWD_T_S001EN, H58.AWD_T_S002EN

It is imperative to adhere to the following:

Product and liability requirements I guidelines (Quality Assurance Association: Locks and Hardware's Directive 'VHBH', as well as previous and applicable documents).

Profile manufacturer or system owner information (PVC or Aluminium) or DIN 68 121 - Timber profiles for windows and balcony doors.

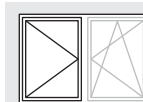

without security

Pos.	Description	Part number	QTY	FFB	FFH	Dimension G	Number of frame parts / Pos.
						In the main sash	45
36	stay 7 DF	707340	1	290- 800			
37	sash lift .. A2000	TFFH0010- ...	1	290- 800			
38	run-up FHITIP	Ref. PDB, TRAL	1	290- 800			
39	shoot bolt VSU A2000	701126	1		365-3000		1
40	shoot bolt VSO A2000	701195	1		365-3000		1
41	striker plate 56 A2000	TRSB0030- ...	1		1001-1200	500	
	striker plate 56 A2000	TRSB0030- ...			1201-1400	600	
	striker plate 56 A2000	TRSB0030- ...			1401-1600	700	
	striker plate 56 A2000	TRSB0030- ...			1601-1800	700	
	striker plate 56 A2000	TRSB0030- ...		2	1801-2000	1000	
	striker plate 56 A2000	TRSB0030- ...		3	2001-3000	1000	
42	striker plate 56 A2000	TRSB0030- ...	1		2401-3000		
43	sash part MV	Ref. PDB, ZFMV01	1		1001-1600		
	sash part MV	Ref. PDB, ZFMV01	2		1601-2400		
	sash part MV	Ref. PDB, ZFMV01	3		2401-3000		
44	frame part MV	Ref. PDB, ZRZM01	1		1001-1600		
	frame part MV	Ref. PDB, ZRZM01	2		1601-2400		
	frame part MV	Ref. PDB, ZRZM01	3		2401-3000		
45	striker V	Ref. PDB, FRZV01					
on request							
46	run-up	Ref. PDB, FRZF06	1		801-3000		
47	striker plate 56 A2000	TRSB0030- ...	1		1801-3000		

Hinge side turning points

Pos.	Description	Part number			required as per sash weight	
		surface TS	RAL9016	RAL8022	100 kg	130 kg
48	stay hinge	Ref. PDB, FBWB			1	1
49	cover cap W timber		FKWB0020-004 ...	FKWB0020-012 ...	1	1
50	top hinge S	Ref. PDB, FBLS02			1	1
51	cover cap S		FKSL0010-004 ...	FKSL0010-012 ...	1	1
52	top hinge pin diam.6	FBSB0010-1 ...			1	1
53	bottom hinge	Ref. PDB, FBEL01			1	
54	bottom hinge S	Ref. PDB, FBEL02				1
55	filling piece H timber	Ref. PDB, FBFS			1	1
56	cover cap EL U		FKEU0010-004 ...	FKEU0010-012 ...	1	
57	cover cap EL-S U		FKEL0010-004 ...	FKEL0010-012 ...		1
58	bottom hinge pin diam.6	TBLB0010-1 ...			1	1
59	reb.cor.hinge	Ref. PDB, TBFE81			1	1
60	cover cap FEB rh.		TKFE7011-004 ...	TKFE7011-012 ...	1	1
	cover cap FEB lh.		TKFE7012-004 ...	TKFE7012-012 ...	1	1

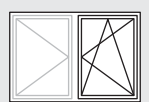

List of fittings main sash
2-sash square tilt-turn turn shoot bolt
H12 GK Hinge side Si-line

FAVORIT
without security

Pos.	Description	Part number	QTY	FFB	FFH	Dimension G	Number of frame parts / Pos.
							14
1a	corn.drive narrow VSO ..	FEUL0520- ...	1	290- 410	431-3000		
1b	corn.drive narrow VSO ..	FEUL0520- ...	1	411- 800	365- 430		1
1c	corn.drive VSO ..	FEUL0230- ...	1	411- 1650			1
2	stay 7 sz 30	707302	1	290- 620			
	stay 7 sz 35 MV	707319		621- 800			
	stay 7 sz 50 MV	707326		801- 1030			
	stay 7 sz 55 MV	707333		1031- 1260			1
	stay 7 sz 50 MV	707326		1261- 1490			1
	stay 7 sz 55 MV	707333		1491- 1650			1
3	linkage SIZ FAV 1V	FZOK0100- ...	1	1261- 1650			1
4	additional stay	Ref. PDB, TSZS	1	1261- 1650			
5	packer Z	Ref. PDB, FRUP01	1	1261- 1650			
6	corn.drive VSU BS sz 50 1V ..	FEUL2070- ...	1	1031- 1260			1
	corn.drive VSU BS sz 70 1V ..	FEUL2080- ...		1261- 1490			1
	corn.drive VSU BS sz 90 1V ..	FEUL2090- ...		1491- 1650			1
7a	gear 15 FAV sz 30IG180	FGKK4010- ...	1	411- 800	365- 430		
	gear 15 FAV sz 30IG180	FGKK4010- ...			431- 600	180	
7b	gear 15 FAV sz 60IG300	FGKK4030- ...	1		601- 800	300	
	gear 15 FAV sz 80IG400 1V	FGKK4050- ...			801- 1000	400	
	gear 15 FAV sz 100IG500 1V	FGKK4060- ...			1001- 1200	500	
	gear 15 FAV sz 120IG600 1V	FGKK4070- ...			1201- 1400	600	
	gear 15 FAV sz 140IG700 2V	FGKK4200- ...			1401- 1600	700	
	gear 15 FAV sz 160IG700 2V 70	FGKK4090- ...			1601- 1800	700	
	gear 15 FAV sz 180IG1000 2V	FGKK4220- ...			1801- 2000	1000	
	gear 15 FAV sz 200IG1000 3V	FGKK4230- ...			2001- 3000	1000	
8	linkage FAV sz 200 A0767	FZSZ0120- ...	1		2201- 2400		
	linkage FAV sz 400 1V	FZSZ0110- ...			2401- 3000		
9	linkage FAV sz 200 A0767	FZSZ0120- ...	1		2601- 2800		
	linkage FAV sz 400 A0767	FZSZ0130- ...			2801- 3000		
10	tilt lock element FAVIFH	FEKB1010- ...	1		601- 3000		
11	handle Globe	Ref.access. ZHGS	1		365- 3000		
12	corn.drive VSU BS sz 50 1V ..	FEUL2070- ...	1		1001- 1200		1
	corn.drive VSU BS sz 70 1V ..	FEUL2080- ...			1201- 1600		1
	corn.drive VSU BS sz 90 1V ..	FEUL2090- ...			1601- 2000		1
	corn.drive BS sz 130 2V ..	FEUL2630- ...			2001- 3000		2
13	MV extension sz 60	700952	1		2401- 3000		1
14	striker plate 56	Ref. PDB, FRSB					
on request							
15	location piece ..	702543	1				
16	frame part SP-S	Ref. PDB, FRZL01	1				
17	sash lift .. A2000	TFFH0010- ...	1		365- 600		
18	run-up FHITIP	Ref. PDB, TRAL	1		365- 600		
19	tilt restrictor ..	805701	1		365- 800		
20	mishandling device FAV.	FFBS0110- ...	1				
21	pressure piece	Ref. PDB, TFFD	1				
22	snapper switchable rh.	TFST0011- ...	1		1801- 3000		
	snapper switchable lh.	TFST0012- ...			1801- 3000		

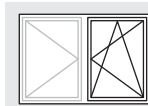

Pos.	Description	Hinge side turning points			required as per sash weight	
		surface TS	Part number		100 kg	130 kg
			RAL9016	RAL8022		
23	stay hinge	Ref. PDB, FBWB			1	1
24	cover cap W timber		FKWB0020-004 ...	FKWB0020-012 ...	1	1
25	top hinge S	Ref. PDB, FBLS02			1	1
26	cover cap S		FKSL0010-004 ...	FKSL0010-012 ...	1	1
27	top hinge pin diam.6	FBSB0010-1 ...			1	1
28	bottom hinge	Ref. PDB, FBEL01			1	
29	bottom hinge S	Ref. PDB, FBEL02				1
30	filling piece H timber	Ref. PDB, FBFS			1	1
31	cover cap EL U		FKEU0010-004 ...	FKEU0010-012 ...	1	
32	cover cap EL-S U		FKEL0010-004 ...	FKEL0010-012 ...		1
33	bottom hinge pin diam.6	TBLB0010-1 ...			1	1
34	reb.cor.hinge	Ref. PDB, TBFE81			1	1
35	cover cap FEB rh.		TKFE7011-004 ...	TKFE7011-012 ...	1	1
	cover cap FEB lh.		TKFE7012-004 ...	TKFE7012-012 ...	1	1

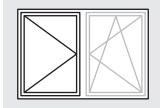

Frame dimensions slave sash
2-sash square tilt-turn turn shoot bolt
H12 GK Hinge side Si-line

FAVORIT
without security

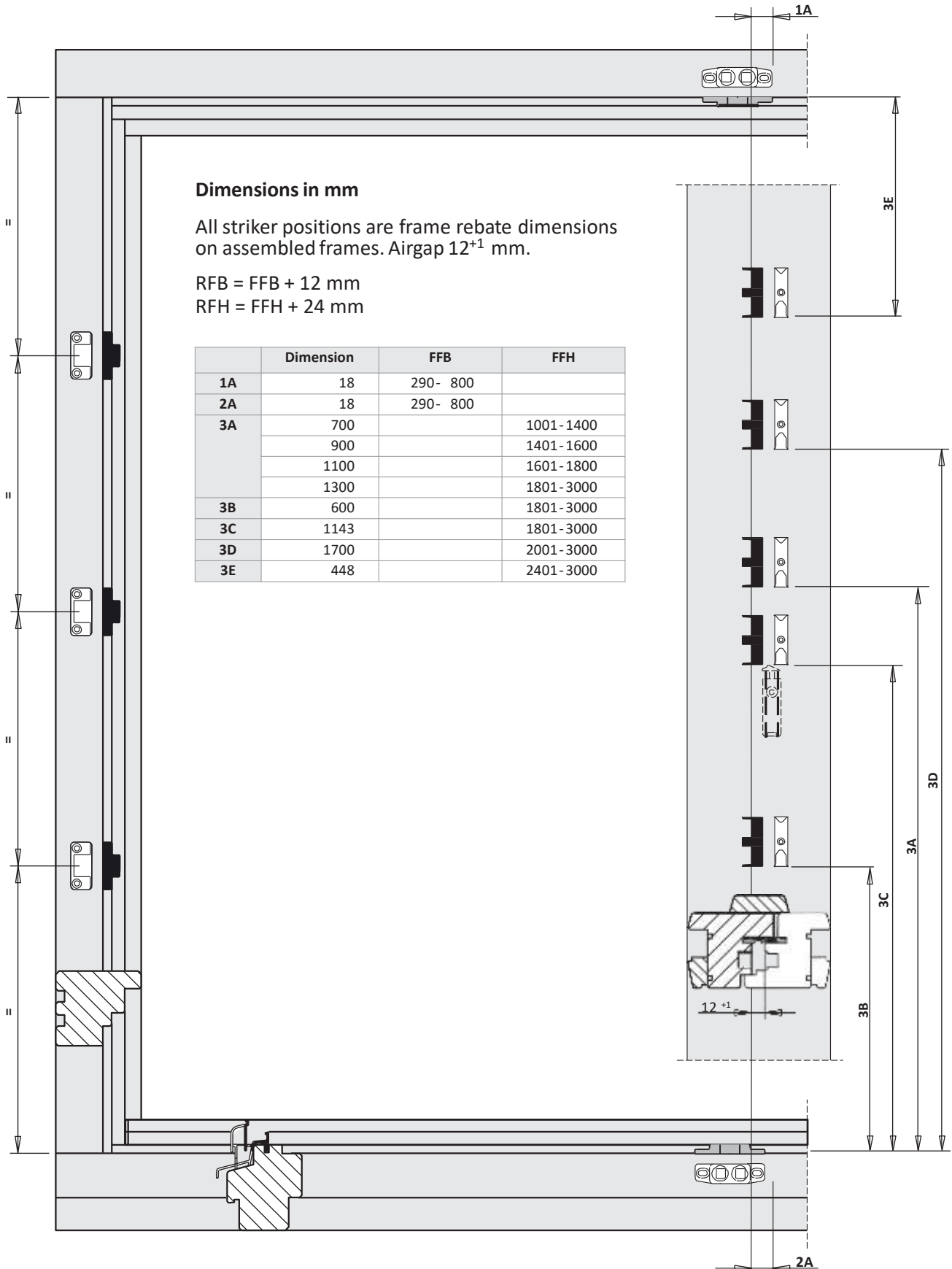

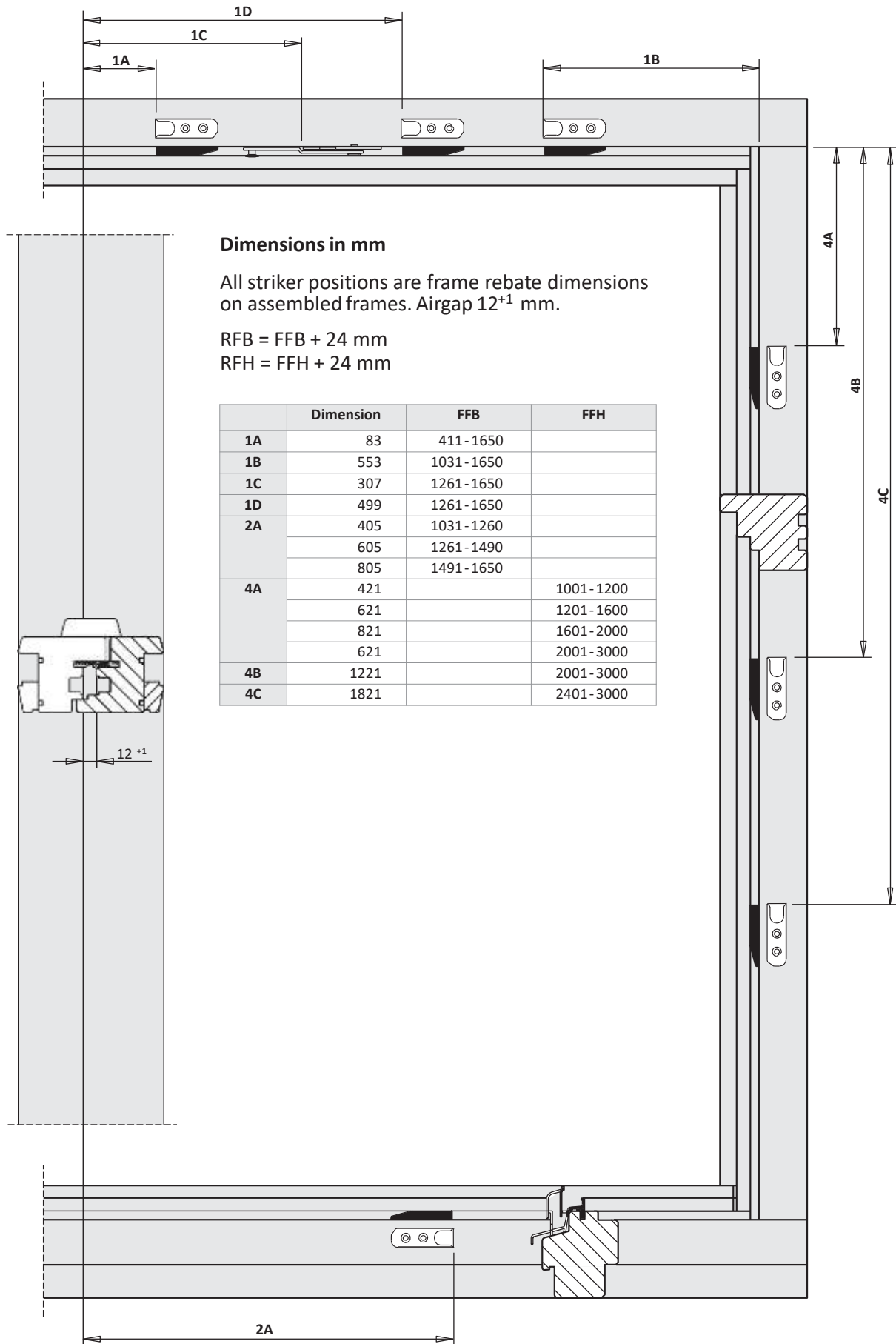
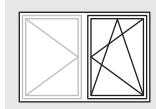

FAVORIT

Installation instructions



1-sash square tilt-turn

timber 12 mm

basic security

fixed handle position

Hinge side Si-line

surface TS

backset 15 mm

5

Hardware set configuration

Hardware set configuration	
General	Locking-points distance 1000
Stay side	one-piece stay
Bottom	loose sash lift
Locking side	mishandl. device on gear
Hinge side	corner drive BS 2V
Hinge side turning points	loose filling pc I pre-mounted

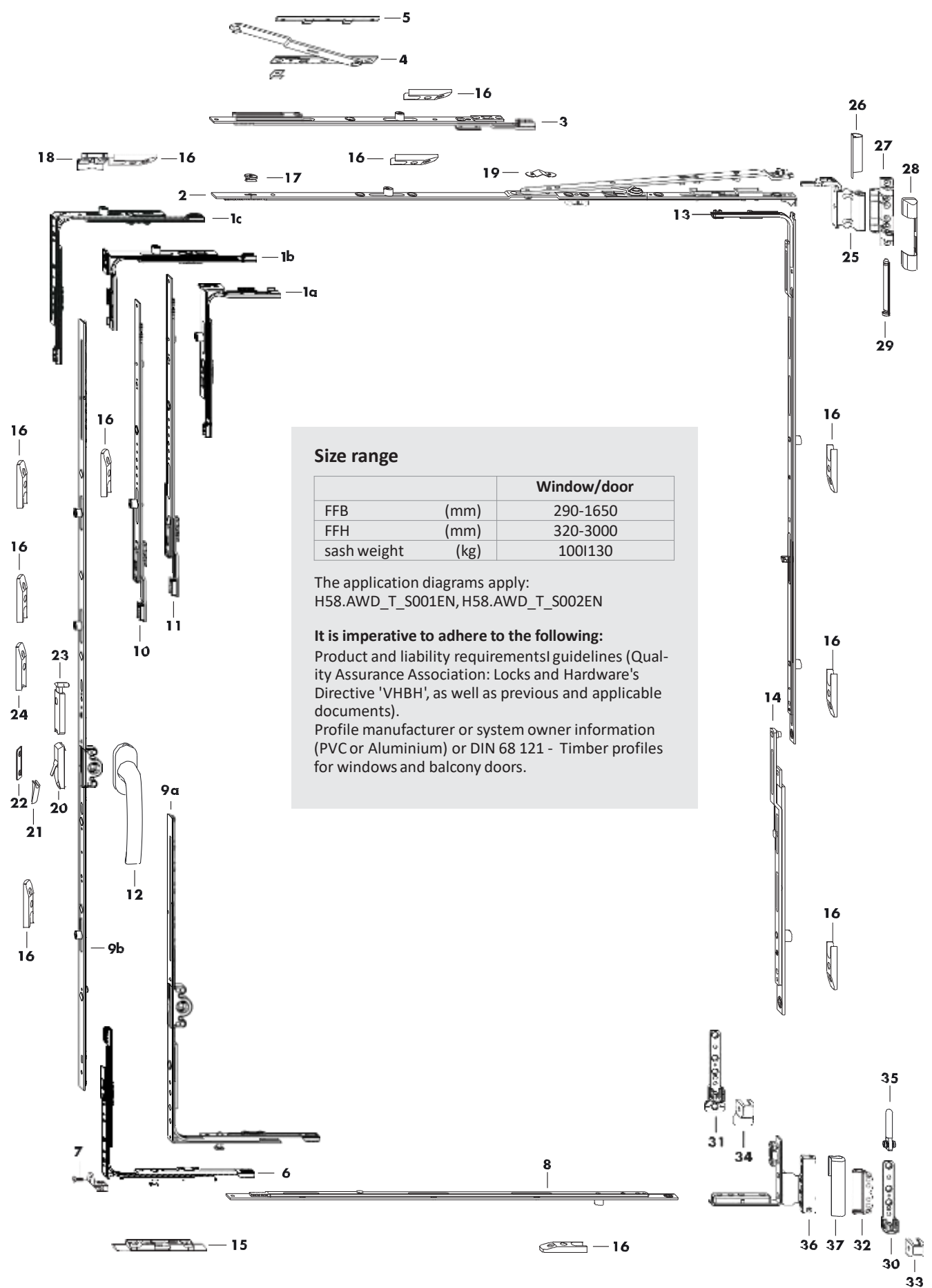

Size range

		Window/door
FFB	(mm)	290-1650
FFH	(mm)	320-3000
sash weight	(kg)	100 130

The application diagrams apply:
H58.AWD_T_S001EN, H58.AWD_T_S002EN

It is imperative to adhere to the following:

Product and liability requirements I guidelines (Quality Assurance Association: Locks and Hardware's Directive 'VHBH', as well as previous and applicable documents).

Profile manufacturer or system owner information (PVC or Aluminium) or DIN 68 121 - Timber profiles for windows and balcony doors.



List of fittings
1-sash square tilt-turn
H12 GK Hinge side Si-line

FAVORIT

GS

Pos.	Description	Part number	QTY	FFB	FFH	Dimension G	Number of frame parts / Pos.	
							15	16
1a	corn.drive narrow VSO ..	FEUL0520- ...	1	290- 410	431-3000			1
1b	corn.drive narrow VSO ..	FEUL0520- ...	1	411- 800	320- 430			1
1c	corn.drive VSO ..	FEUL0230- ...	1	411- 1650	431-3000			1
2	stay 7 sz 30	707302	1	290- 620				
	stay 7 sz 35 MV	707319		621- 800				
	stay 7 sz 50 MV	707326		801- 1030				
	stay 7 sz 55 MV	707333		1031- 1260				1
	stay 7 sz 50 MV	707326		1261- 1490				1
	stay 7 sz 55 MV	707333		1491- 1650				1
3	linkage SIZ FAV 1V	FZOK0100- ...	1	1261- 1650				1
4	additional stay	Ref. PDB, TSZS	1	1261- 1650				
5	packer Z	Ref. PDB, FRUP01	1	1261- 1650				
6	corn.drive FAV VS 1S ..	FEUL0510- ...	1	290- 1650	601-3000		1	
7	sash lift S-ES	Ref. PDB, FMFH	1	290- 1650				
8	centre lock sz 50	700969	1	1031- 1260				1
	centre lock sz 70	700976		1261- 1490				1
	centre lock sz 90	700983		1491- 1650				1
9a	gear 15 FAV sz 30IG180 S-ES	FGKK4020- ...	1	411- 800	320- 430	180	1	
	gear 15 FAV sz 30IG180 S-ES	FGKK4020- ...		290- 1260	431- 600	180	1	
9b	gear 15 FAV sz 60IG300	FGKK4030- ...	1		601- 800	300		
	gear 15 FAV sz 80IG400 1V	FGKK4050- ...			801- 1000	400		
	gear 15 FAV sz 100IG500 1V	FGKK4060- ...			1001- 1200	500		1
	gear 15 FAV sz 120IG600 1V	FGKK4070- ...			1201- 1400	600		1
	gear 15 FAV sz 140IG700 2V	FGKK4200- ...			1401- 1600	700		1
	gear 15 FAV sz 160IG700 2V 70	FGKK4090- ...			1601- 1800	700		1
	gear 15 FAV sz 180IG1000 2V	FGKK4220- ...			1801- 2000	1000		2
	gear 15 FAV sz 200IG1000 3V	FGKK4230- ...			2001- 3000	1000		3
10	linkage FAV sz 200 A0767	FZSZ0120- ...	1		2201- 2400			
	linkage FAV sz 400 1V	FZSZ0110- ...			2401- 3000			1
11	linkage FAV sz 200 A0767	FZSZ0120- ...	1		2601- 2800			
	linkage FAV sz 400 A0767	FZSZ0130- ...			2801- 3000			
12	handle Globe	Ref.access. ZHGS	1		320- 3000			
13	corn.drive VSU BS sz 50 1V ..	FEUL2070- ...	1		1001- 1200			1
	corn.drive VSU BS sz 70 1V ..	FEUL2080- ...			1201- 1600			1
	corn.drive VSU BS sz 90 1V ..	FEUL2090- ...			1601- 2000			1
	corn.drive BS sz 130 2V ..	FEUL2630- ...			2001- 3000			2
14	MV extension sz 60	700952	1		2401- 3000			1
15	tilt lock bear. S-ES FH	Ref. PDB, FRKA						
16	striker plate 56	Ref. PDB, FRSB						
on request								
17	location piece ..	702543	1					
18	frame part SP-S	Ref. PDB, FRZL01	1					
19	tilt restrictor ..	805701	1		320- 800			
20	mishandling device FAV.	FFBS0110- ...	1					
21	pressure piece	Ref. PDB, TFFD	1					
22	stop	Ref. PDB, FRZF01	1					
23	snapper switchable rh.	TFST0011- ...	1		1801- 3000			
	snapper switchable lh.	TFST0012- ...			1801- 3000			
24	frame part snapper	Ref. PDB, TRST	1		1801- 3000			

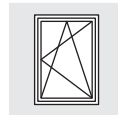

Pos.	Description	Hinge side turning points			required as per sash weight	
		surface TS	Part number		100 kg	130 kg
			RAL9016	RAL8022		
25	stay hinge	Ref. PDB, FBWB			1	1
26	cover cap W timber		FKWB0020-004 ...	FKWB0020-012 ...	1	1
27	top hinge S	Ref. PDB, FBLS02			1	1
28	cover cap S		FKSL0010-004 ...	FKSL0010-012 ...	1	1
29	top hinge pin diam.6	FBSB0010-1 ...			1	1
30	bottom hinge	Ref. PDB, FBEL01			1	
31	bottom hinge S	Ref. PDB, FBEL02				1
32	filling piece H timber	Ref. PDB, FBFS			1	1
33	cover cap EL U		FKEU0010-004 ...	FKEU0010-012 ...	1	
34	cover cap EL-S U		FKEL0010-004 ...	FKEL0010-012 ...		1
35	bottom hinge pin diam.6	TBLB0010-1 ...			1	1
36	reb.cor.hinge	Ref. PDB, TBFE81			1	1
37	cover cap FEB rh.		TKFE7011-004 ...	TKFE7011-012 ...	1	1
	cover cap FEB lh.		TKFE7012-004 ...	TKFE7012-012 ...	1	1

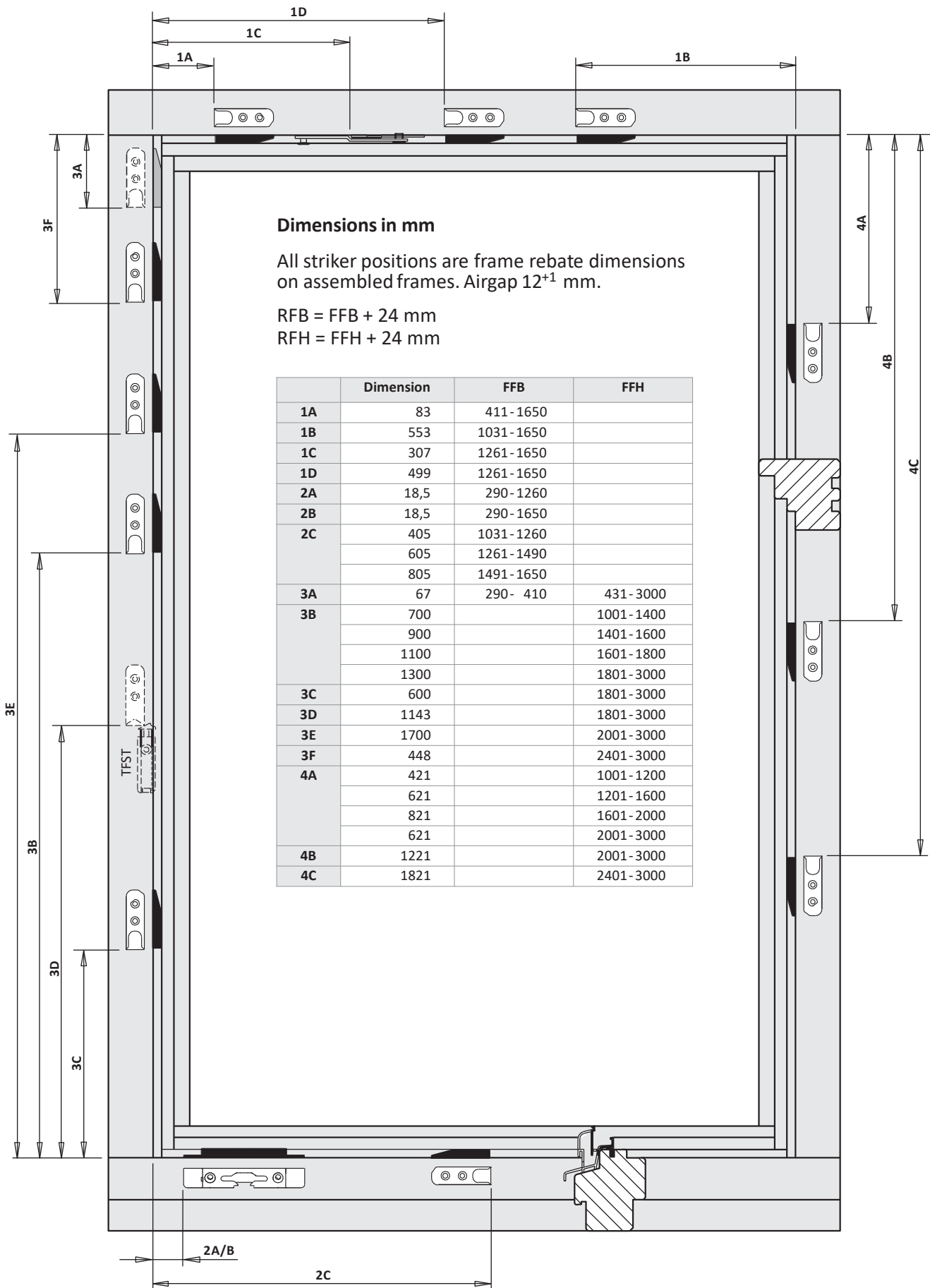

FAVORIT

Installation instructions

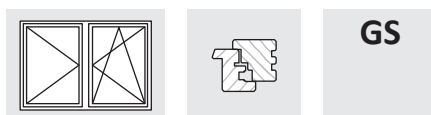

2-sash square tilt-turn/turn DSG gear

timber 12 mm

basic security

fixed handle position

Hinge side Si-line

surface TS

backset 15 mm

5

Hardware set configuration	
General	Locking-points distance 1000
Stay side	one-piece stay
Bottom	loose sash lift
Locking side	mishandl. device on gear
Hinge side	corner drive BS 2V
Hinge side turning points	loose filling pc I pre-mounted

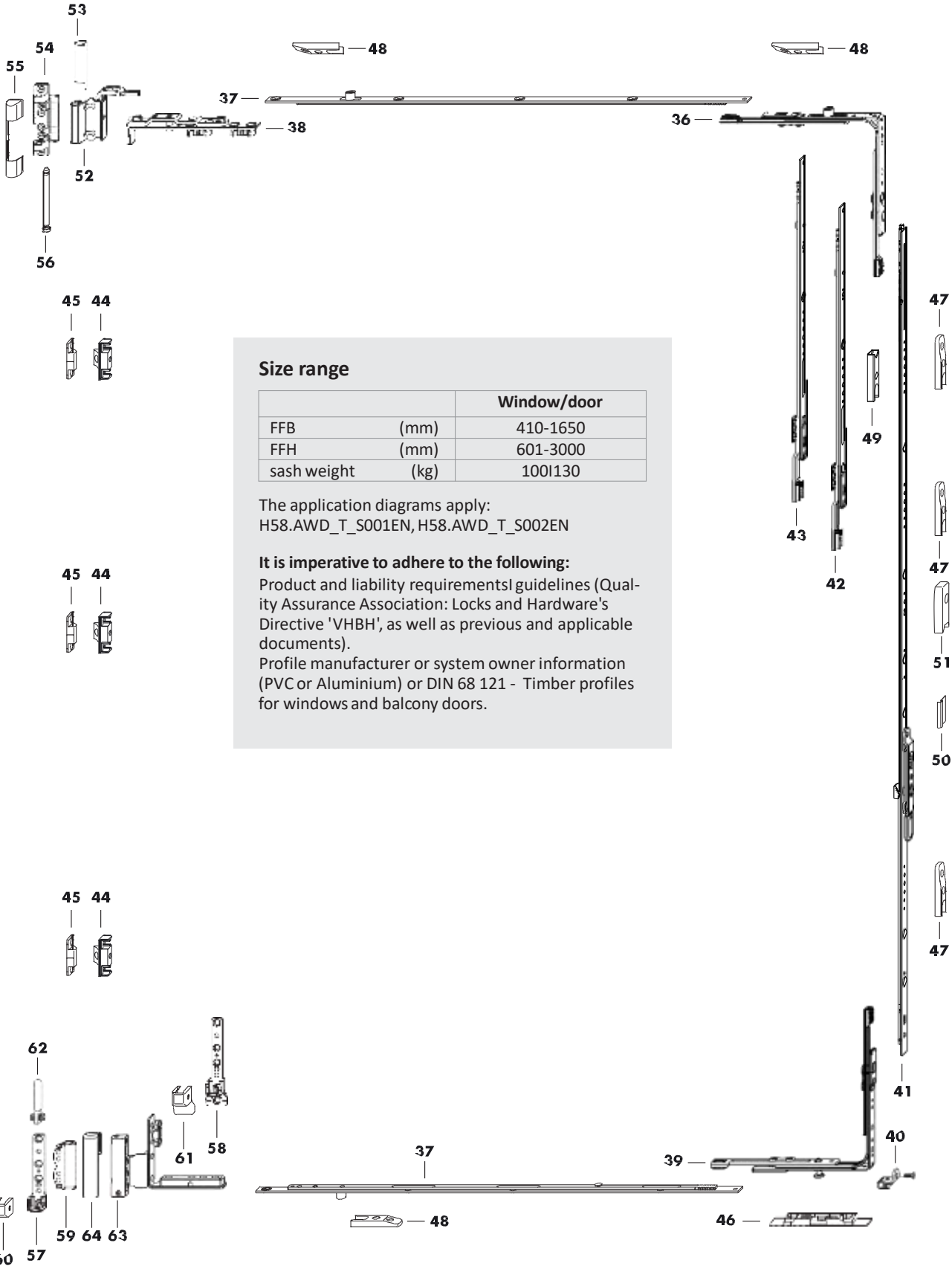
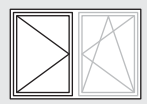

Size range

		Window/door
FFB	(mm)	410-1650
FFH	(mm)	601-3000
sash weight	(kg)	100 130

The application diagrams apply:
H58.AWD_T_S001EN, H58.AWD_T_S002EN

It is imperative to adhere to the following:

Product and liability requirements (Quality Assurance Association: Locks and Hardware's Directive 'VHBH', as well as previous and applicable documents).

Profile manufacturer or system owner information (PVC or Aluminium) or DIN 68 121 - Timber profiles for windows and balcony doors.

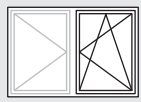

hardware layout main sash

2-sash square tilt-turn DSG gear
H12 GK Hinge side Si-line

FAVORIT

GS

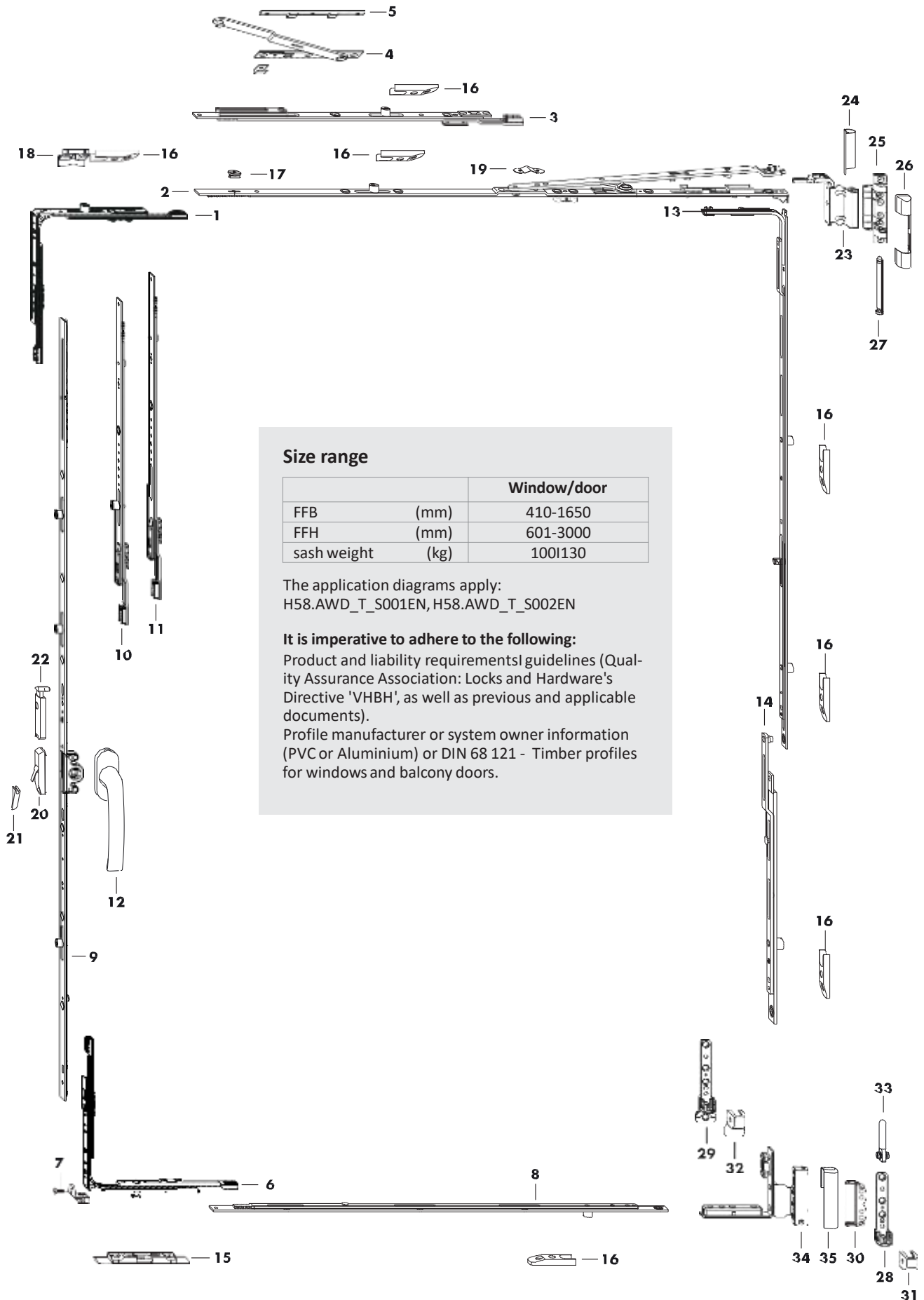

Size range

		Window/door
FFB	(mm)	410-1650
FFH	(mm)	601-3000
sash weight	(kg)	100 130

The application diagrams apply:
H58.AWD_T_S001EN, H58.AWD_T_S002EN

It is imperative to adhere to the following:

Product and liability requirements| guidelines (Quality Assurance Association: Locks and Hardware's Directive 'VHBH', as well as previous and applicable documents).

Profile manufacturer or system owner information (PVC or Aluminium) or DIN 68 121 - Timber profiles for windows and balcony doors.



Pos.	Description	Part number	QTY	FFB	FFH	Dimension G	Number of frame parts / Pos.			
						In the main sash	46	47	48	49
36	corn.drive VSO ..	FEUL0230- ...	1	410- 1650					1	
37	centre lock sz 50	700969	2	1031- 1260					2	
	centre lock sz 70	700976		1261- 1490					2	
	centre lock sz 90	700983		1491- 1650					2	
38	stay 7 DF	707340	1	410- 1650						
39	corn.drive FAV VS 1S ..	FEUL0510- ...	1	410- 1650			1			
40	sash lift S-ES	Ref. PDB, FMFH	1	410- 1650						
41	s.sash gear16 FAV 60I300	FGKS4030- ...	1		601- 800	300				
	s.sash gear16 FAV 80I400 1SB	FGKS4050- ...			801- 1000	400				
	s.sash gear16 FAV 100I500 1SB	FGKS4060- ...			1001- 1200	500		1		
	s.sash gear16 FAV 120I600 1SB	FGKS4070- ...			1201- 1400	600		1		
	s.sash gear16 FAV 140I700 2SB	FGKS4290- ...			1401- 1600	700		1		
	s.sash gear16 FAV 160I700 2SB	FGKS4330- ...			1601- 1800	700		1		
	s.sash gear16 FAV 180I1000 2SB	FGKS4100- ...			1801- 2000	1000		1		
	s.sash gear16 FAV 200I1000 3SB	FGKS4280- ...			2001- 3000	1000		1		
42	linkage FAV sz 200 A0767	FZSZ0120- ...	1		2201- 2400					
	linkage FAV sz 400 A0767	FZSZ0130- ...			2401- 3000					1
43	linkage FAV sz 200 A0767	FZSZ0120- ...	1		2601- 2800					1
	linkage FAV sz 400 A0767	FZSZ0130- ...			2801- 3000					
44	sash part MV	Ref. PDB, ZFMV01	1		1001- 1600					
	sash part MV	Ref. PDB, ZFMV01	2		1601- 2400					
	sash part MV	Ref. PDB, ZFMV01	3		2401- 3000					
45	frame part MV	Ref. PDB, ZRZM01	1		1001- 1600					
	frame part MV	Ref. PDB, ZRZM01	2		1601- 2400					
	frame part MV	Ref. PDB, ZRZM01	3		2401- 3000					
46	tilt lock bear. S-ES FH	Ref. PDB, FRKA								
47	striker plate f. gear MV	Ref. PDB, FRSA02								
48	striker plate 56	Ref. PDB, FRSB								
49	striker plate 56 A0767	TRSB0020- ...								
on request										
50	stop	Ref. PDB, FRZF04	1		801- 3000					
51	striker snapper A0767	TRST0010- ...	1		1801- 3000					

Pos.	Description	Hinge side turning points				required as per sash weight	
		Part number			100 kg	130 kg	
		surface TS	RAL9016	RAL8022			
52	stay hinge	Ref. PDB, FBWB			1	1	
53	cover cap W timber		FKWB0020-004 ...	FKWB0020-012 ...	1	1	
54	top hinge S	Ref. PDB, FBLS02			1	1	
55	cover cap S		FKSL0010-004 ...	FKSL0010-012 ...	1	1	
56	top hinge pin diam.6	FBSB0010-1 ...			1	1	
57	bottom hinge	Ref. PDB, FBEL01			1		
58	bottom hinge S	Ref. PDB, FBEL02				1	
59	filling piece H timber	Ref. PDB, FBFS			1	1	
60	cover cap EL U		FKEU0010-004 ...	FKEU0010-012 ...	1		
61	cover cap EL-S U		FKEL0010-004 ...	FKEL0010-012 ...		1	
62	bottom hinge pin diam.6	TBLB0010-1 ...			1	1	
63	reb.cor.hinge	Ref. PDB, TBFE81			1	1	
64	cover cap FEB rh.		TKFE7011-004 ...	TKFE7011-012 ...	1	1	
	cover cap FEB lh.		TKFE7012-004 ...	TKFE7012-012 ...	1	1	

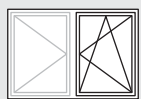

List of fittings main sash

2-sash square tilt-turn turn DSG gear
H12 GK Hinge side Si-line

FAVORIT

GS

Pos.	Description	Part number	QTY	FFB	FFH	Dimension G	Number of frame parts / Pos.	
							15	16
1a	corn.drive narrow VSO ..	FEUL0520- ...	1	410- 410				
1b	corn.drive VSO ..	FEUL0230- ...	1	411- 1650				1
2	stay 7 sz 30	707302	1	410- 620				
	stay 7 sz 35 MV	707319		621- 800				
	stay 7 sz 50 MV	707326		801- 1030				
	stay 7 sz 55 MV	707333		1031- 1260				1
	stay 7 sz 50 MV	707326		1261- 1490				1
	stay 7 sz 55 MV	707333		1491- 1650				1
3	linkage SIZ FAV 1V	FZOK0100- ...	1	1261- 1650				1
4	additional stay	Ref. PDB, TSZS	1	1261- 1650				
5	packer Z	Ref. PDB, FRUP01	1	1261- 1650				
6	corn.drive FAV VS 1S ..	FEUL0510- ...	1	410- 1650			1	
7	sash lift S-ES	Ref. PDB, FMFH	1	410- 1650				
8	centre lock sz 50	700969	1	1031- 1260				1
	centre lock sz 70	700976		1261- 1490				1
	centre lock sz 90	700983		1491- 1650				1
9	gear 15 FAV sz 60IG300	FGKK4030- ...	1		601- 800	300		
	gear 15 FAV sz 80IG400 1V	FGKK4050- ...			801- 1000	400		
	gear 15 FAV sz 100IG500 1V	FGKK4060- ...			1001- 1200	500		
	gear 15 FAV sz 120IG600 1V	FGKK4070- ...			1201- 1400	600		
	gear 15 FAV sz 140IG700 2V	FGKK4200- ...			1401- 1600	700		
	gear 15 FAV sz 160IG700 2V 70	FGKK4090- ...			1601- 1800	700		
	gear 15 FAV sz 180IG1000 2V	FGKK4220- ...			1801- 2000	1000		
	gear 15 FAV sz 200IG1000 3V	FGKK4230- ...			2001- 3000	1000		
10	linkage FAV sz 200 A0767	FZSZ0120- ...	1		2201- 2400			
	linkage FAV sz 400 1V	FZSZ0110- ...			2401- 3000			
11	linkage FAV sz 200 A0767	FZSZ0120- ...	1		2601- 2800			
	linkage FAV sz 400 A0767	FZSZ0130- ...			2801- 3000			
12	handle Globe	Ref.access. ZHGS	1		601- 3000			
13	corn.drive VSU BS sz 50 1V ..	FEUL2070- ...	1		1001- 1200			1
	corn.drive VSU BS sz 70 1V ..	FEUL2080- ...			1201- 1600			1
	corn.drive VSU BS sz 90 1V ..	FEUL2090- ...			1601- 2000			1
	corn.drive BS sz 130 2V ..	FEUL2630- ...			2001- 3000			2
14	MV extension sz 60	700952	1		2401- 3000			1
15	tilt lock bear. S-ES FH	Ref. PDB, FRKA						
16	striker plate 56	Ref. PDB, FRSB						
on request								
17	location piece ..	702543	1					
18	frame part SP-S	Ref. PDB, FRZL01	1	411- 1650				
19	tilt restrictor ..	805701	1		601- 800			
20	mishandling device FAV.	FFBS0110- ...	1		801- 3000			
21	pressure piece	Ref. PDB, TFFD	1		801- 3000			
22	snapper switchable rh.	TFST0011- ...	1		1801- 3000			
	snapper switchable lh.	TFST0012- ...			1801- 3000			

Hinge side turning points						
Pos.	Description	Part number			required as per sash weight	
		surface TS	RAL9016	RAL8022	100 kg	130 kg
23	stay hinge	Ref. PDB, FBWB			1	1
24	cover cap W timber		FKWB0020-004 ...	FKWB0020-012 ...	1	1
25	top hinge S	Ref. PDB, FBLS02			1	1
26	cover cap S		FKSL0010-004 ...	FKSL0010-012 ...	1	1
27	top hinge pin diam.6	FBSB0010-1 ...			1	1
28	bottom hinge	Ref. PDB, FBEL01			1	
29	bottom hinge S	Ref. PDB, FBEL02				1
30	filling piece H timber	Ref. PDB, FBFS			1	1
31	cover cap EL U		FKEU0010-004 ...	FKEU0010-012 ...	1	
32	cover cap EL-S U		FKEL0010-004 ...	FKEL0010-012 ...		1
33	bottom hinge pin diam.6	TBLB0010-1 ...			1	1
34	reb.cor.hinge	Ref. PDB, TBFE81			1	1
35	cover cap FEB rh.		TKFE7011-004 ...	TKFE7011-012 ...	1	1
	cover cap FEB lh.		TKFE7012-004 ...	TKFE7012-012 ...	1	1

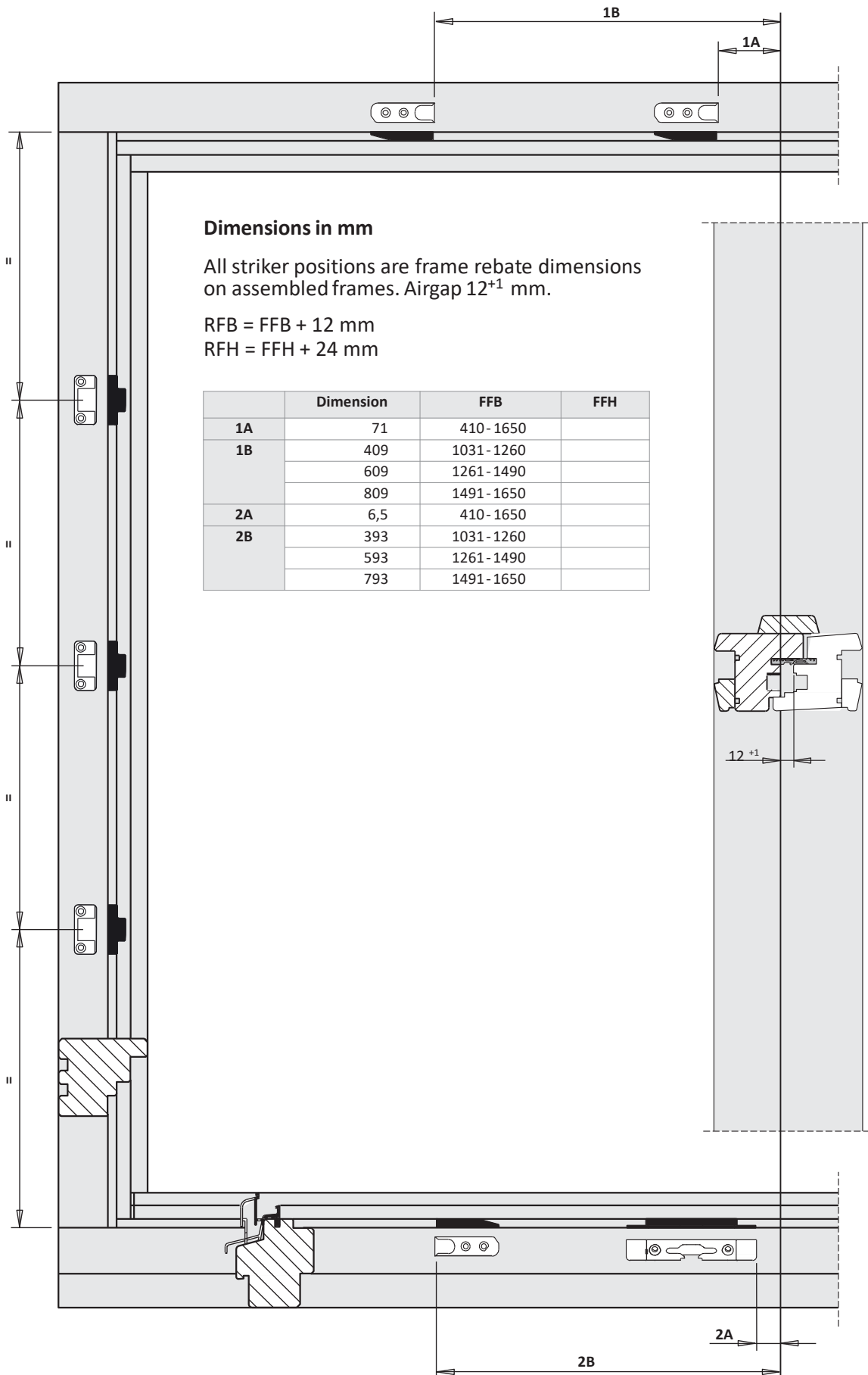
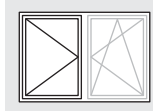

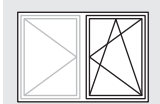

Frame dimensions main sash
 2-sash square tilt-turn turn DSG gear
 H12 GK Hinge side Si-line

FAVORIT

GS

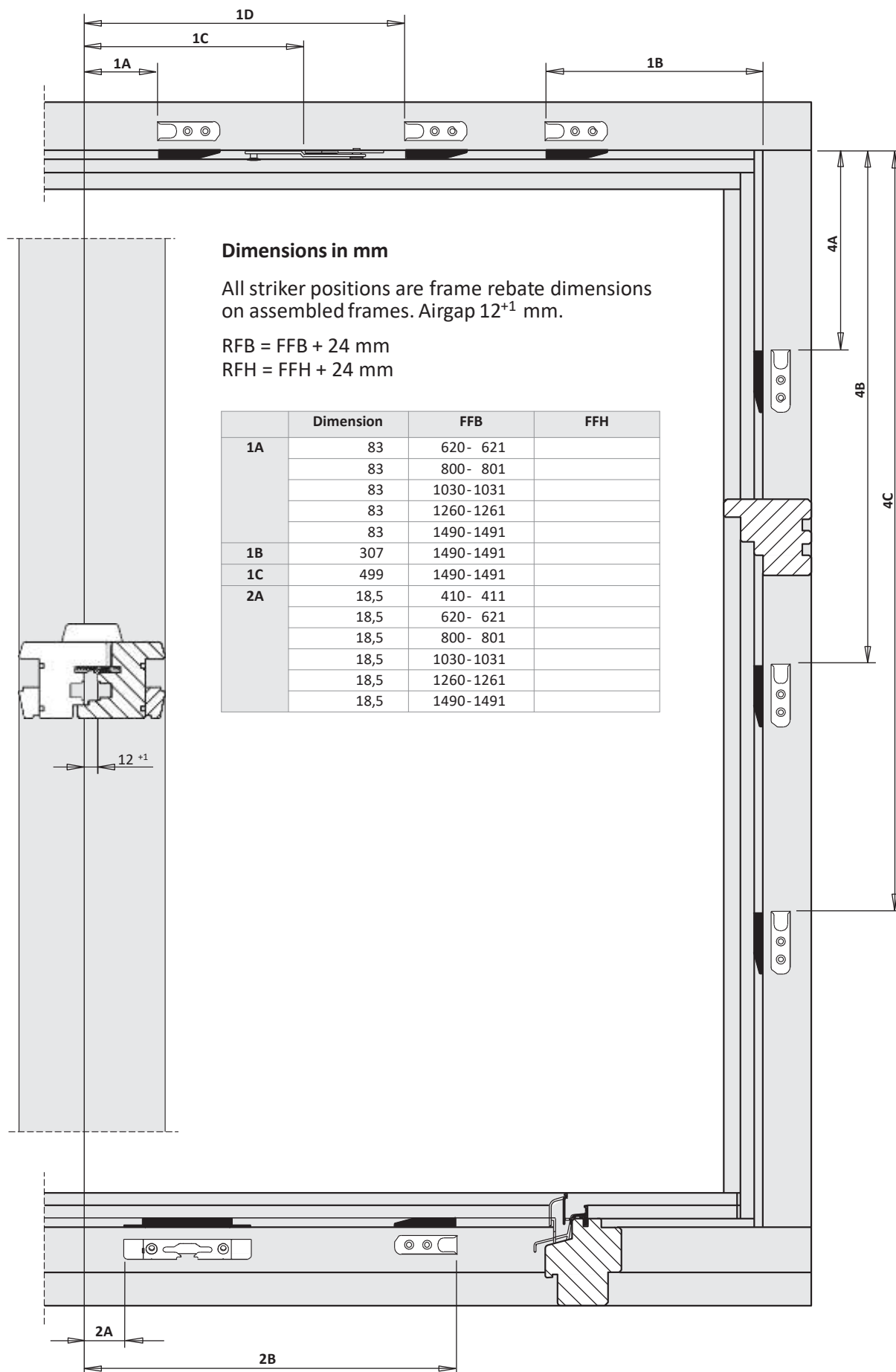

5

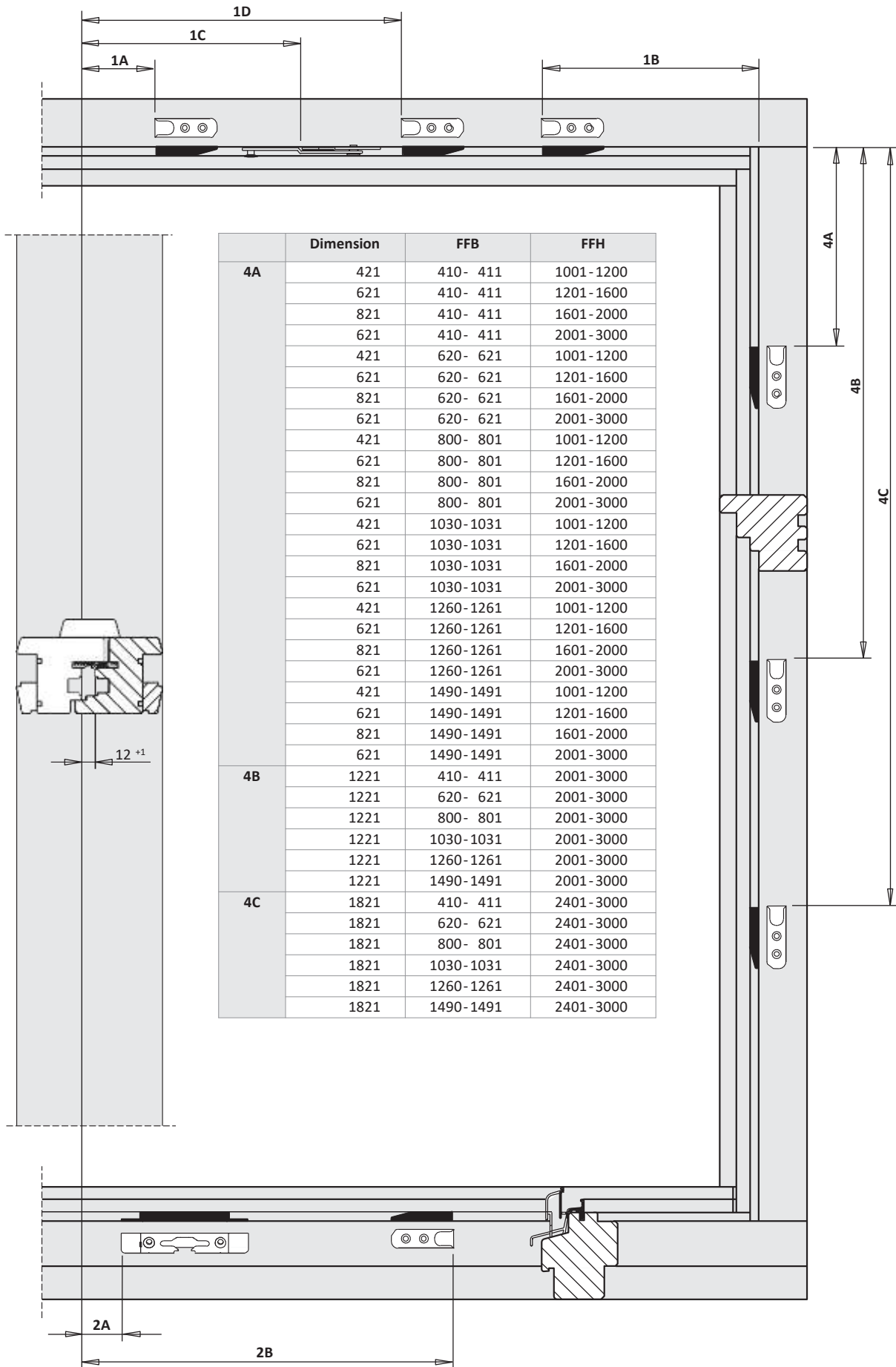
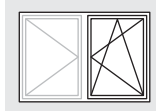

	Dimension	FFB	FFH
4A	421	410- 411	1001-1200
	621	410- 411	1201-1600
	821	410- 411	1601-2000
	621	410- 411	2001-3000
	421	620- 621	1001-1200
	621	620- 621	1201-1600
	821	620- 621	1601-2000
	621	620- 621	2001-3000
	421	800- 801	1001-1200
	621	800- 801	1201-1600
	821	800- 801	1601-2000
	621	800- 801	2001-3000
	421	1030-1031	1001-1200
	621	1030-1031	1201-1600
	821	1030-1031	1601-2000
621	1030-1031	2001-3000	
421	1260-1261	1001-1200	
621	1260-1261	1201-1600	
821	1260-1261	1601-2000	
621	1260-1261	2001-3000	
421	1490-1491	1001-1200	
621	1490-1491	1201-1600	
821	1490-1491	1601-2000	
621	1490-1491	2001-3000	
4B	1221	410- 411	2001-3000
	1221	620- 621	2001-3000
	1221	800- 801	2001-3000
	1221	1030-1031	2001-3000
	1221	1260-1261	2001-3000
	1221	1490-1491	2001-3000
4C	1821	410- 411	2401-3000
	1821	620- 621	2401-3000
	1821	800- 801	2401-3000
	1821	1030-1031	2401-3000
	1821	1260-1261	2401-3000
	1821	1490-1491	2401-3000

5

FAVORIT

Installation instructions

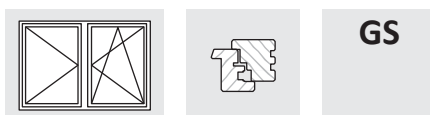

2-sash square tilt-turn/turn DS gear

timber 12 mm

basic security

fixed handle position

Hinge side Si-line

surface TS

backset 15 mm

Hardware set configuration	
General	Locking-points distance 1000
Stay side	one-piece stay
Bottom	loose sash lift
Locking side	mishandl. device on gear
Hinge side	corner drive BS 2V
Hinge side turning points	loose filling pc I pre-mounted

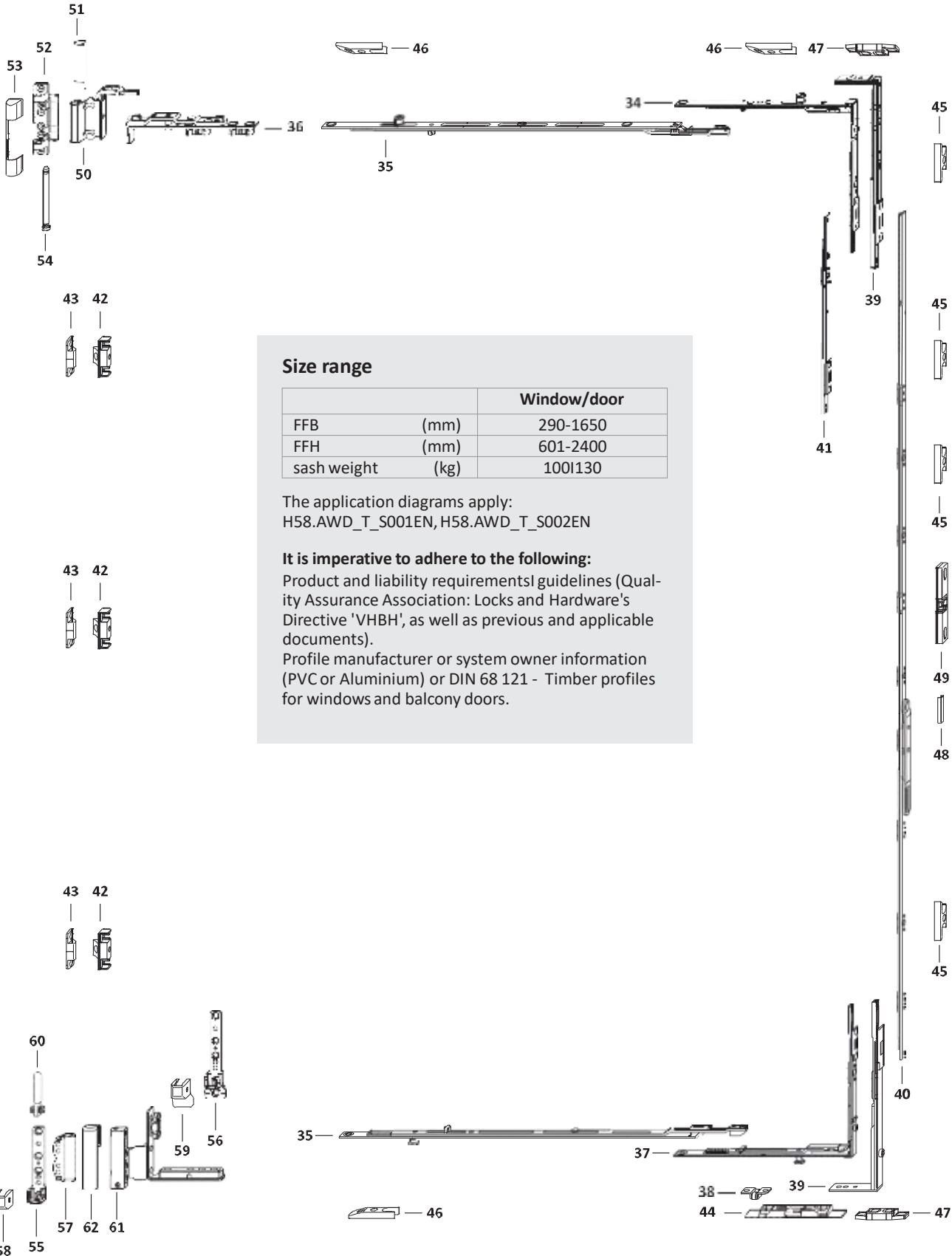
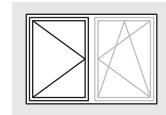

Size range

		Window/door
FFB	(mm)	290-1650
FFH	(mm)	601-2400
sash weight	(kg)	100 130

The application diagrams apply:
 H58.AWD_T_S001EN, H58.AWD_T_S002EN

It is imperative to adhere to the following:
 Product and liability requirements | guidelines (Quality Assurance Association: Locks and Hardware's Directive 'VHBH', as well as previous and applicable documents).
 Profile manufacturer or system owner information (PVC or Aluminium) or DIN 68 121 - Timber profiles for windows and balcony doors.

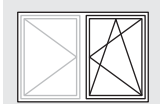

hardware layout main sash
2-sash square tilt-turn DS gear
H12 GK Hinge side Si-line

FAVORIT

GS

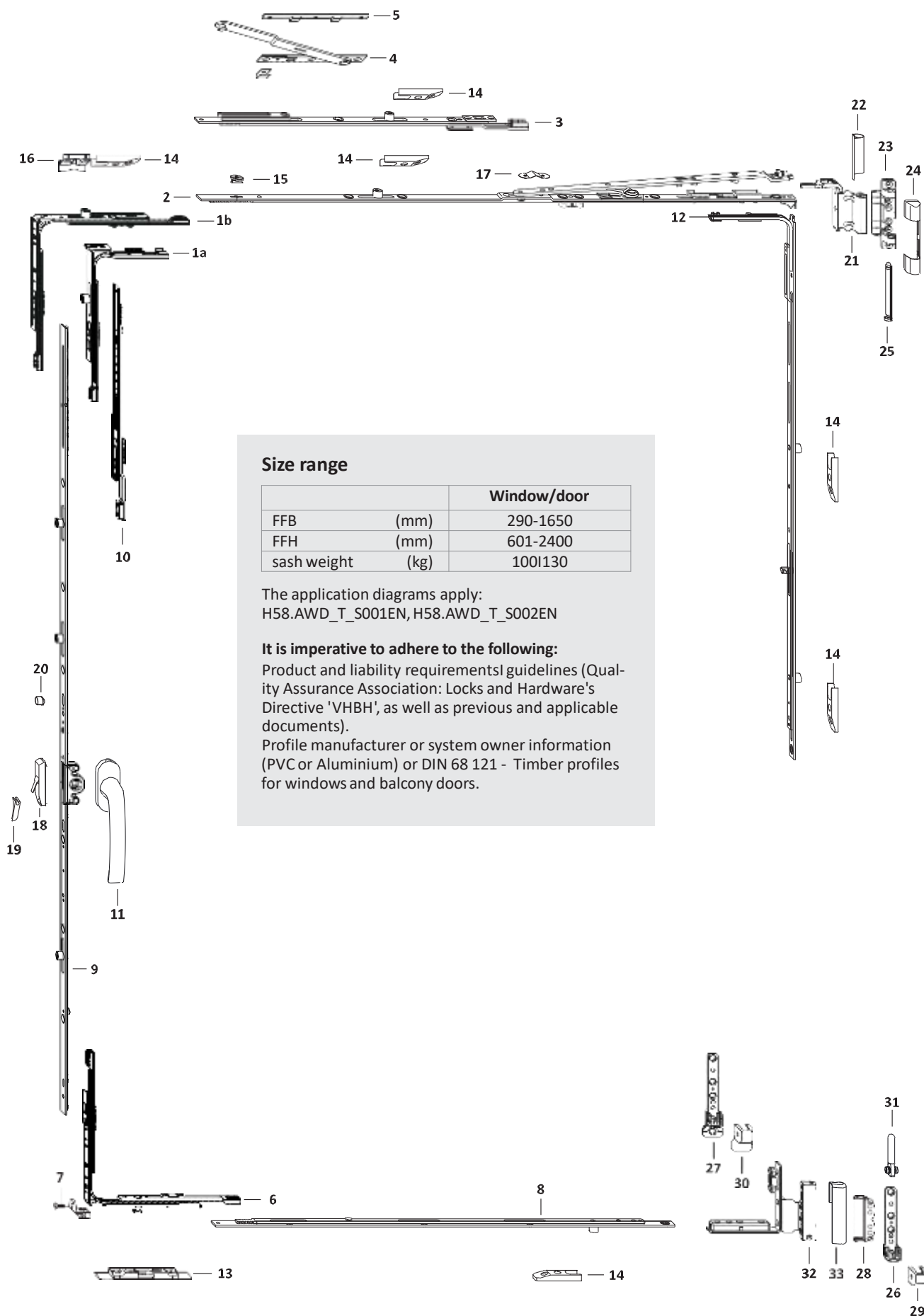

Size range

		Window/door
FFB	(mm)	290-1650
FFH	(mm)	601-2400
sash weight	(kg)	100 130

The application diagrams apply:
H58.AWD_T_S001EN, H58.AWD_T_S002EN

It is imperative to adhere to the following:

Product and liability requirements| guidelines (Quality Assurance Association: Locks and Hardware's Directive 'VHBH', as well as previous and applicable documents).

Profile manufacturer or system owner information (PVC or Aluminium) or DIN 68 121 - Timber profiles for windows and balcony doors.

List of fittings slave sash

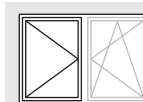
2-sash square tilt-turn/turn DS gear
H12 GK Hinge side Si-line

Pos.	Description	Part number	QTY	FFB	FFH	Dimension G	Number of frame parts / Pos.			
						In the main sash	44	45	46	47
34	corn.drive VSOIK+ DS 1RS	TEUL4120- ...	1	411 - 1650					1	
35	linkage BSIFH sz 2+ 1RS	TZBS0190- ...	2	1031 - 1260					2	
	linkage BSIFH sz 3+ 1RS	TZBS0200- ...		1261 - 1650					2	
36	stay 7 DF	707340	1	290 - 1650						
37	corn.drive AF VSUIK+ DS 1S	TEUL1230- ...	1	411 - 1650			1			
38	sash lift ..	TFFH0020- ...	1	411 - 1650						
39	locking bolt VSO-DS	703274	2	290- 410	601-2400					2
40	sec.sash gear 8 sz 60IG300	TGKS1030- ...	1		601- 800	300				
	sec.sash gear 8 sz 80IG400	TGKS1050- ...			801- 1000	400				
	sec.sash gear 8 sz 100IG500	TGKS1060- ...			1001-1200	500	1			
	sec.sash gear 8 sz 120IG600	TGKS1070- ...			1201-1400	600	1			
	sec.sash gear 8 sz 140IG700 70	TGKS1160- ...			1401-1600	700	1			
	sec.sash gear 8 160IG700 2SB70 70	TGKS1150- ...			1601-1800	700	1			
	sec.sash gear 8 sz 180IG1000 2 70	TGKS1170- ...			1801-2000	1000	1			
	sec.sash gear 8 sz 200IG1000 3 70	TGKS1180- ...			2001-2400	1000	1			
41	linkage KS sec.sash 8 sz 1	TZKS1010- ...	1		2201-2400					
42	sash part MV	Ref. PDB, ZFMV01	1		1001-1600					
	sash part MV	Ref. PDB, ZFMV01	2		1601-2400					
43	frame part MV	Ref. PDB, ZRZM01	1		1001-1600					
	frame part MV	Ref. PDB, ZRZM01	2		1601-2400					
44	tilt lock bear. S-ES FH	Ref. PDB, FRKA								
45	striker plate f. gear TL	Ref. PDB, FRSA05								
46	striker plate 56	Ref. PDB, FRSB								
47	striker V	Ref. PDB, FRZV02								
on request										
48	stop	Ref. PDB, FRZF05	1		801-2400					
49	snapper	Ref. PDB, FRZB03	1		1801-2400					

Pos.	Description	Hinge side turning points			required as per sash weight	
		Part number	Part number	Part number	100 kg	130 kg
50	stay hinge	surface TS	RAL9016	RAL8022	1	1
51	cover cap W timber	Ref. PDB, FBWB	FKWB0020-004 ...	FKWB0020-012 ...	1	1
52	top hinge S	Ref. PDB, FBLS02			1	1
53	cover cap S		FKSL0010-004 ...	FKSL0010-012 ...	1	1
54	top hinge pin diam.6	FBSB0010-1 ...			1	1
55	bottom hinge	Ref. PDB, FBEL01			1	
56	bottom hinge S	Ref. PDB, FBEL02				1
57	filling piece H timber	Ref. PDB, FBFS			1	1
58	cover cap EL U		FKEU0010-004 ...	FKEU0010-012 ...	1	
59	cover cap EL-S U		FKEL0010-004 ...	FKEL0010-012 ...		1
60	bottom hinge pin diam.6	TBLB0010-1 ...			1	1
61	reb.cor.hinge	Ref. PDB, TBFE81			1	1
62	cover cap FEB rh.		TKFE7011-004 ...	TKFE7011-012 ...	1	1
	cover cap FEB lh.		TKFE7012-004 ...	TKFE7012-012 ...	1	1

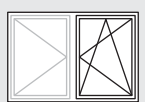

List of fittings main sash
2-sash square tilt-turn turn DS gear
H12 GK Hinge side Si-line

FAVORIT

GS

Pos.	Description	Part number	QTY	FFB	FFH	Dimension G	Number of frame parts / Pos.	
							13	14
1a	corn.drive narrow VSO ..	FEUL0520- ...	1	290- 410				
1b	corn.drive VSO ..	FEUL0230- ...	1	411 - 1650				1
2	stay 7 sz 30	707302	1	290- 620				
	stay 7 sz 35 MV	707319		621- 800				
	stay 7 sz 50 MV	707326		801- 1030				
	stay 7 sz 55 MV	707333		1031- 1260				1
	stay 7 sz 50 MV	707326		1261- 1490				1
	stay 7 sz 55 MV	707333		1491- 1650				1
3	linkage SIZ FAV 1V	FZOK0100- ...	1	1261- 1650				1
4	additional stay	Ref. PDB, TSZS	1	1261- 1650				
5	packer Z	Ref. PDB, FRUP01	1	1261- 1650				
6	corn.drive FAV VS 1S ..	FEUL0510- ...	1	290- 1650			1	
7	sash lift S-ES	Ref. PDB, FMFH	1	290- 1650				
8	centre lock sz 50	700969	1	1031- 1260				1
	centre lock sz 70	700976		1261- 1490				1
	centre lock sz 90	700983		1491- 1650				1
9	gear 15 FAV sz 60IG300	FGKK4030- ...	1		601- 800	300		
	gear 15 FAV sz 80IG400 1V	FGKK4050- ...			801- 1000	400		
	gear 15 FAV sz 100IG500 1V	FGKK4060- ...			1001- 1200	500		
	gear 15 FAV sz 120IG600 1V	FGKK4070- ...			1201- 1400	600		
	gear 15 FAV sz 140IG700 2V	FGKK4200- ...			1401- 1600	700		
	gear 15 FAV sz 160IG700 2V 70	FGKK4090- ...			1601- 1800	700		
	gear 15 FAV sz 180IG1000 2V	FGKK4220- ...			1801- 2000	1000		
	gear 15 FAV sz 200IG1000 3V	FGKK4230- ...			2001- 2400	1000		
10	linkage FAV sz 200 A0767	FZS0120- ...	1		2201- 2400			
11	handle Globe	Ref.access. ZHGS	1		601- 2400			
12	corn.drive VSU BS sz 50 1V ..	FEUL2070- ...	1		1001- 1200			1
	corn.drive VSU BS sz 70 1V ..	FEUL2080- ...			1201- 1600			1
	corn.drive VSU BS sz 90 1V ..	FEUL2090- ...			1601- 2000			1
	corn.drive BS sz 130 2V ..	FEUL2630- ...			2001- 2400			2
13	tilt lock bear. S-ES FH	Ref. PDB, FRKA						
14	striker plate 56	Ref. PDB, FRSB						
on request								
15	location piece ..	702543	1					
16	frame part SP-S	Ref. PDB, FRZL01	1	411 - 1650				
17	tilt restrictor ..	805701	1		601- 800			
18	mishandling device FAV.	FFBS0110- ...	1		801- 2400			
19	pressure piece	Ref. PDB, TFFD	1		801- 2400			
20	sleeve DS	Ref. PDB, FFHU03	1		1801- 2400			

Pos.	Description	Hinge side turning points			required as per sash weight	
		Part number			100 kg	130 kg
		surface TS	RAL9016	RAL8022		
21	stay hinge	Ref. PDB, FBWB			1	1
22	cover cap W timber		FKWB0020-004 ...	FKWB0020-012 ...	1	1
23	top hinge S	Ref. PDB, FBSL02			1	1
24	cover cap S		FKSL0010-004 ...	FKSL0010-012 ...	1	1
25	top hinge pin diam.6	FBSB0010-1 ...			1	1
26	bottom hinge	Ref. PDB, FBEL01			1	
27	bottom hinge S	Ref. PDB, FBEL02				1
28	filling piece H timber	Ref. PDB, FBFS			1	1
29	cover cap EL U		FKEU0010-004 ...	FKEU0010-012 ...	1	
30	cover cap EL-S U		FKEL0010-004 ...	FKEL0010-012 ...		1
31	bottom hinge pin diam.6	TBLB0010-1 ...			1	1
32	reb.cor.hinge	Ref. PDB, TBFE81			1	1
33	cover cap FEB rh.		TKFE7011-004 ...	TKFE7011-012 ...	1	1
	cover cap FEB lh.		TKFE7012-004 ...	TKFE7012-012 ...	1	1

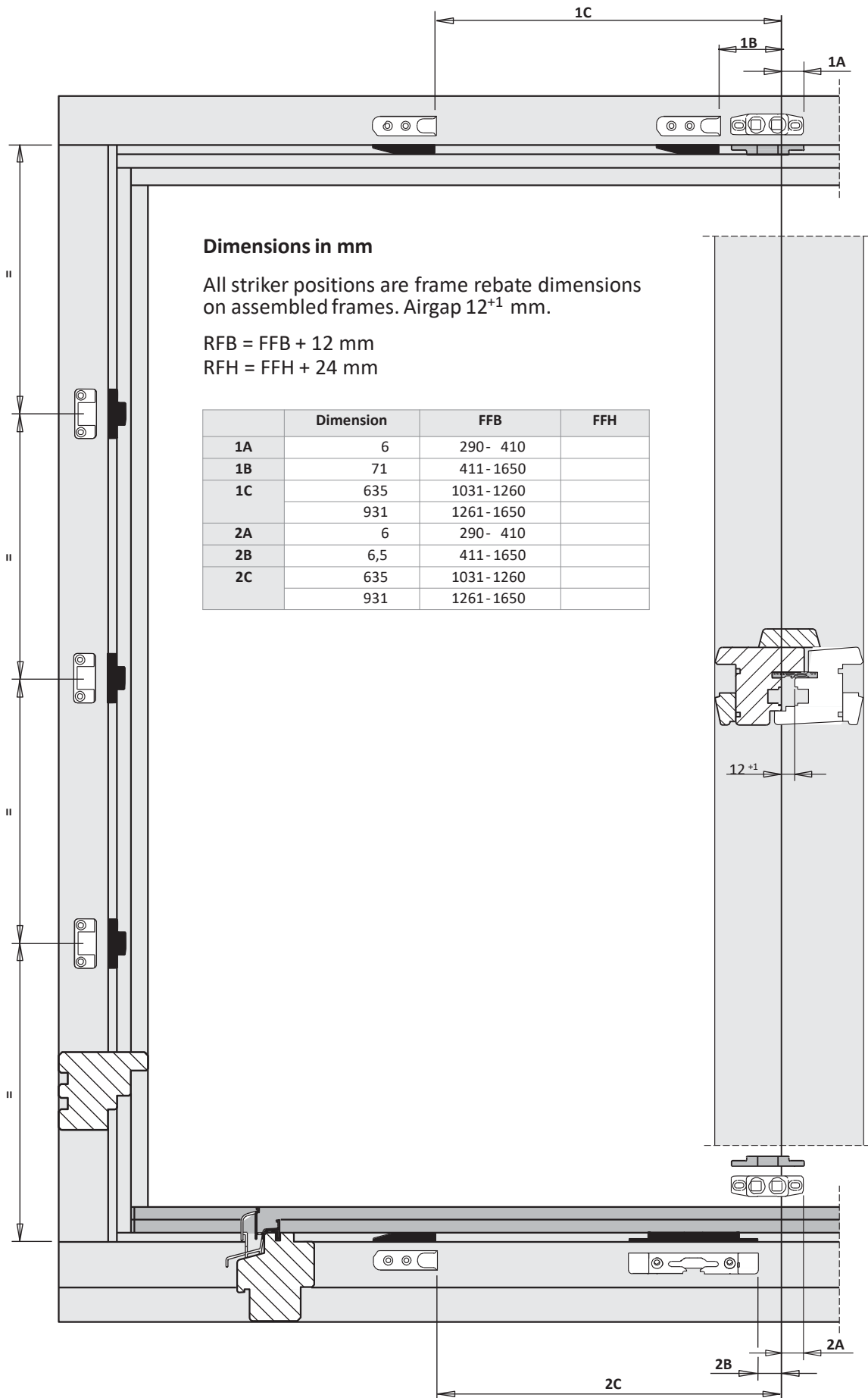
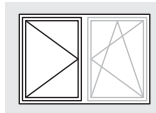

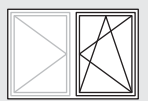

Frame dimensions main sash
2-sash square tilt-turn turn DS gear
H12 GK Hinge side Si-line

FAVORIT

GS

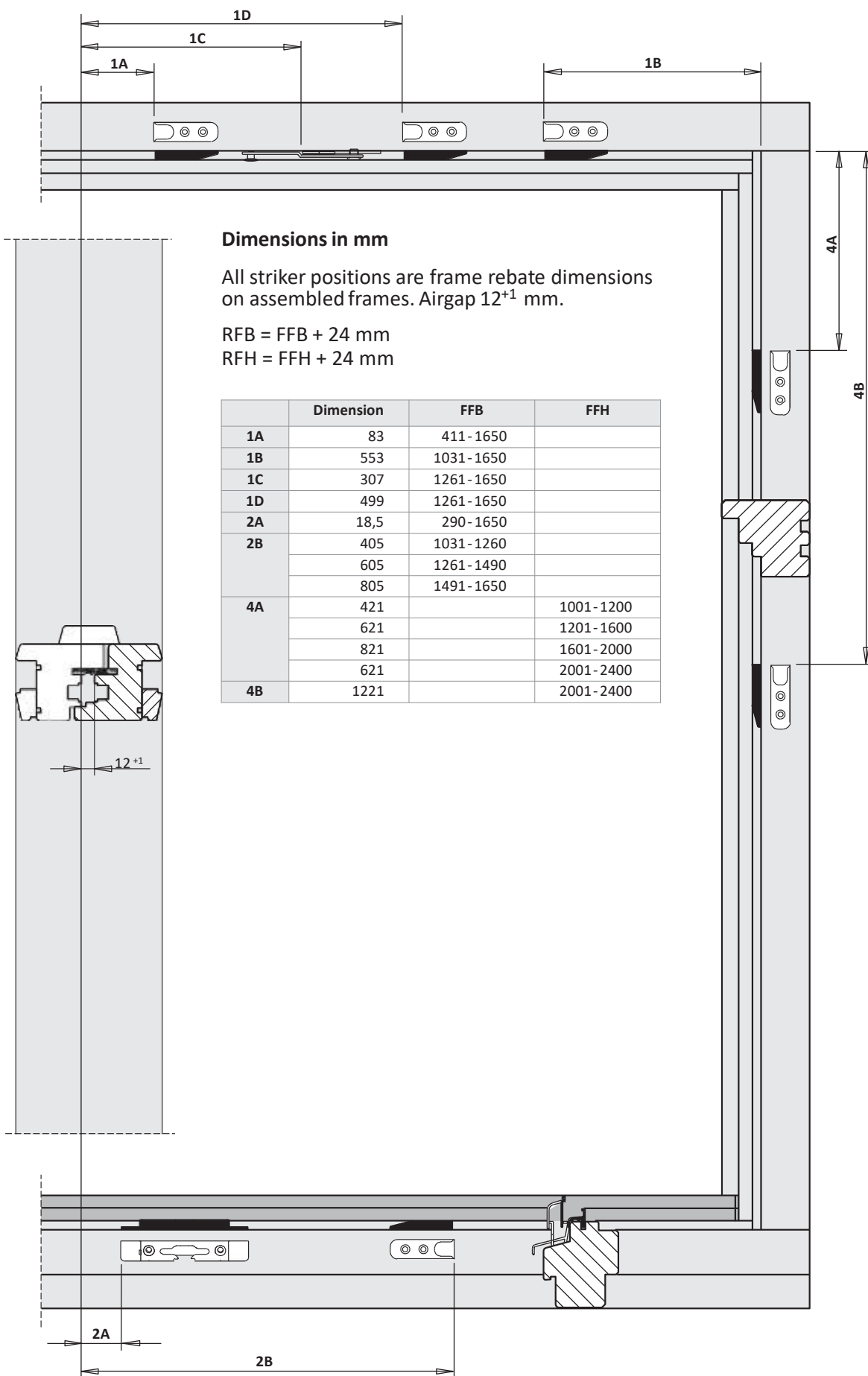

5

FAVORIT

Installation instructions

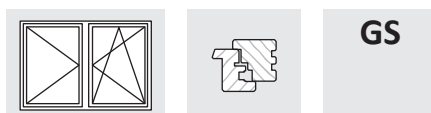

2-sash square tilt-turn turn shoot bolt

timber 12 mm

basic security

fixed handle position

Hinge side Si-line

surface TS

backset 15 mm

5

Hardware set configuration	
General	Locking-points distance 1000
Stay side	one-piece stay
Bottom	loose sash lift
Locking side	mishandl. device on gear
Hinge side	corner drive BS 2V
Hinge side turning points	loose filling pc I pre-mounted

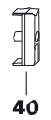
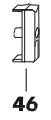
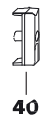
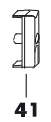
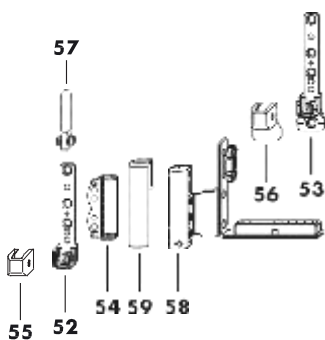
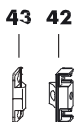
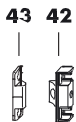
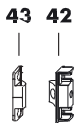
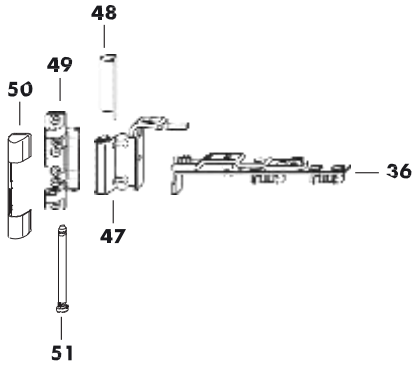
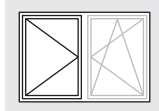

Size range

		Window/door
FFB	(mm)	230-1030
FFH	(mm)	320-3000
sash weight	(kg)	100 130

The application diagrams apply:
H58.AWD_T_S001EN, H58.AWD_T_S002EN

It is imperative to adhere to the following:

Product and liability requirements/guidelines (Quality Assurance Association: Locks and Hardware's Directive 'VHBH', as well as previous and applicable documents).

Profile manufacturer or system owner information (PVC or Aluminium) or DIN 68 121 - Timber profiles for windows and balcony doors.

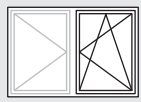

hardware layout main sash

2-sash square tilt-turn shoot bolt

H12 GK Hinge side Si-line

FAVORIT

GS

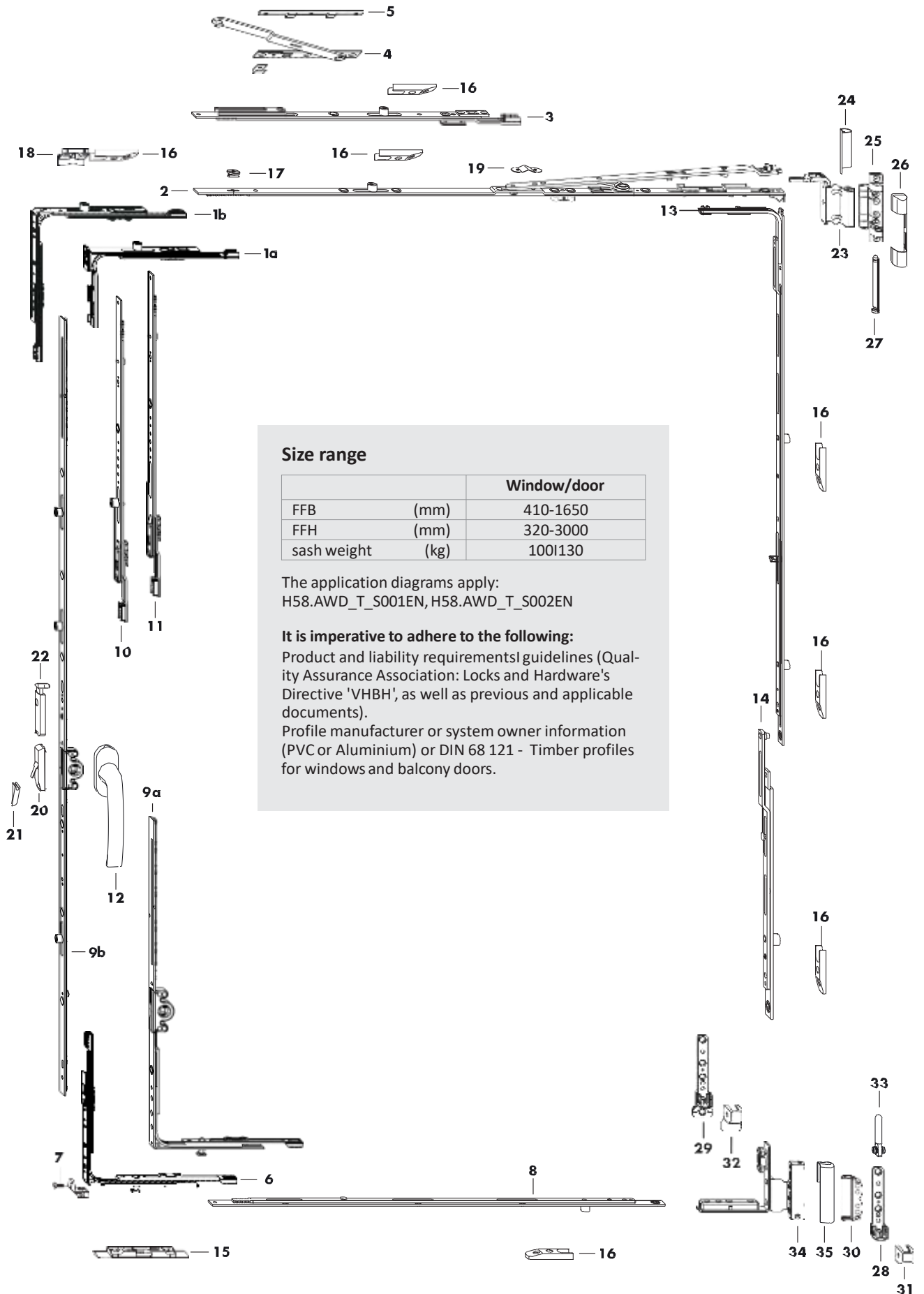

Size range

		Window/door
FFB	(mm)	410-1650
FFH	(mm)	320-3000
sash weight	(kg)	100 130

The application diagrams apply:
H58.AWD_T_S001EN, H58.AWD_T_S002EN

It is imperative to adhere to the following:

Product and liability requirements| guidelines (Quality Assurance Association: Locks and Hardware's Directive 'VHBH', as well as previous and applicable documents).

Profile manufacturer or system owner information (PVC or Aluminium) or DIN 68 121 - Timber profiles for windows and balcony doors.

List of fittings slave sash

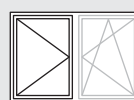
2-sash square tilt-turn/turn shoot bolt
H12 GK Hinge side Si-line

Pos.	Description	Part number	QTY	FFB	FFH	Dimension G	Number of frame parts / Pos.
						In the main sash	44
36	stay 7 DF	707340	1	230-1030			
37	sash lift .. A2000	TFFH0010- ...	1	230-1030			
38	run-up FHITiP	Ref. PDB, TRAL	1	230-1030			
39	short shoot bolt A2000	716236	2		320-3000		2
40	striker plate 56 A2000	TRSB0030- ...	1		1001-1200	500	
	striker plate 56 A2000	TRSB0030- ...			1201-1400	600	
	striker plate 56 A2000	TRSB0030- ...			1401-1600	700	
	striker plate 56 A2000	TRSB0030- ...			1601-1800	700	
	striker plate 56 A2000	TRSB0030- ...		2	1801-2000	1000	
	striker plate 56 A2000	TRSB0030- ...	3	2001-3000	1000		
41	striker plate 56 A2000	TRSB0030- ...	1		2401-3000		
42	sash part MV	Ref. PDB, ZFMV01	1		1001-1600		
	sash part MV	Ref. PDB, ZFMV01	2		1601-2400		
	sash part MV	Ref. PDB, ZFMV01	3		2401-3000		
43	frame part MV	Ref. PDB, ZRZM01	1		1001-1600		
	frame part MV	Ref. PDB, ZRZM01	2		1601-2400		
	frame part MV	Ref. PDB, ZRZM01	3		2401-3000		
44	striker V	Ref. PDB, FRZV01					
on request							
45	run-up	Ref. PDB, FRZF06	1		801-3000		
46	striker plate 56 A2000	TRSB0030- ...	1		1801-3000		

Hinge side turning points

Pos.	Description	Part number			required as per sash weight	
		surface TS	RAL9016	RAL8022	100 kg	130 kg
47	stay hinge	Ref. PDB, FBWB			1	1
48	cover cap W timber		FKWB0020-004 ...	FKWB0020-012 ...	1	1
49	top hinge S	Ref. PDB, FBLS02			1	1
50	cover cap S		FKSL0010-004 ...	FKSL0010-012 ...	1	1
51	top hinge pin diam.6	FBSB0010-1 ...			1	1
52	bottom hinge	Ref. PDB, FBEL01			1	
53	bottom hinge S	Ref. PDB, FBEL02				1
54	filling piece H timber	Ref. PDB, FBFS			1	1
55	cover cap EL U		FKEU0010-004 ...	FKEU0010-012 ...	1	
56	cover cap EL-S U		FKEL0010-004 ...	FKEL0010-012 ...		1
57	bottom hinge pin diam.6	TBLB0010-1 ...			1	1
58	reb.cor.hinge	Ref. PDB, TBFE81			1	1
59	cover cap FEB rh.		TKFE7011-004 ...	TKFE7011-012 ...	1	1
	cover cap FEB lh.		TKFE7012-004 ...	TKFE7012-012 ...	1	1

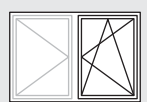

List of fittings main sash

2-sash square tilt-turn turn shoot bolt

H12 GK Hinge side Si-line

FAVORIT

GS

Pos.	Description	Part number	QTY	FFB	FFH	Dimension G	Number of frame parts / Pos.	
							15	16
1a	corn.drive narrow VSO ..	FEUL0520- ...	1	410- 800	320- 430			1
1b	corn.drive VSO ..	FEUL0230- ...	1	410-1650	431-3000			1
2	stay 7 sz 30	707302	1	410- 620				
	stay 7 sz 35 MV	707319		621- 800				
	stay 7 sz 50 MV	707326		801-1030				
	stay 7 sz 55 MV	707333		1031-1260				1
	stay 7 sz 50 MV	707326		1261-1490				1
	stay 7 sz 55 MV	707333		1491-1650				1
3	linkage SIZ FAV 1V	FZOK0100- ...	1	1261-1650				1
4	additional stay	Ref. PDB, TSZS	1	1261-1650				
5	packer Z	Ref. PDB, FRUP01	1	1261-1650				
6	corn.drive FAV VS 1S ..	FEUL0510- ...	1	410-1650	601-3000		1	
7	sash lift S-ES	Ref. PDB, FMFH	1	410-1650				
8	centre lock sz 50	700969	1	1031-1260				1
	centre lock sz 70	700976		1261-1490				1
	centre lock sz 90	700983		1491-1650				1
9a	gear 15 FAV sz 30IG180 S-ES	FGKK4020- ...	1	410- 800	320- 430	180	1	
	gear 15 FAV sz 30IG180 S-ES	FGKK4020- ...		410-1260	431- 600	180	1	
9b	gear 15 FAV sz 60IG300	FGKK4030- ...	1		601- 800	300		
	gear 15 FAV sz 80IG400 1V	FGKK4050- ...			801-1000	400		
	gear 15 FAV sz 100IG500 1V	FGKK4060- ...			1001-1200	500		
	gear 15 FAV sz 120IG600 1V	FGKK4070- ...			1201-1400	600		
	gear 15 FAV sz 140IG700 2V	FGKK4200- ...			1401-1600	700		
	gear 15 FAV sz 160IG700 2V 70	FGKK4090- ...			1601-1800	700		
	gear 15 FAV sz 180IG1000 2V	FGKK4220- ...			1801-2000	1000		
	gear 15 FAV sz 200IG1000 3V	FGKK4230- ...			2001-3000	1000		
10	linkage FAV sz 200 A0767	FZSZ0120- ...	1		2201-2400			
	linkage FAV sz 400 1V	FZSZ0110- ...			2401-3000			
11	linkage FAV sz 200 A0767	FZSZ0120- ...	1		2601-2800			
	linkage FAV sz 400 A0767	FZSZ0130- ...			2801-3000			
12	handle Globe	Ref.access. ZHGS	1		320-3000			
13	corn.drive VSU BS sz 50 1V ..	FEUL2070- ...	1		1001-1200			1
	corn.drive VSU BS sz 70 1V ..	FEUL2080- ...			1201-1600			1
	corn.drive VSU BS sz 90 1V ..	FEUL2090- ...			1601-2000			1
	corn.drive BS sz 130 2V ..	FEUL2630- ...			2001-3000			2
14	MV extension sz 60	700952	1		2401-3000			1
15	tilt lock bear. S-ES FH	Ref. PDB, FRKA						
16	striker plate 56	Ref. PDB, FRSB						
on request								
17	location piece ..	702543	1					
18	frame part SP-S	Ref. PDB, FRZL01	1					
19	tilt restrictor ..	805701	1		320- 800			
20	mishandling device FAV.	FFBS0110- ...	1		801-3000			
21	pressure piece	Ref. PDB, TFFD	1		801-3000			
22	snapper switchable rh.	TFST0011- ...	1		1801-3000			
	snapper switchable lh.	TFST0012- ...			1801-3000			

Hinge side turning points

Pos.	Description	Part number			required as per sash weight	
		surface TS	RAL9016	RAL8022	100 kg	130 kg
23	stay hinge	Ref. PDB, FBWB			1	1
24	cover cap W timber		FKWB0020-004 ...	FKWB0020-012 ...	1	1
25	top hinge S	Ref. PDB, FBLS02			1	1
26	cover cap S		FKSL0010-004 ...	FKSL0010-012 ...	1	1
27	top hinge pin diam.6	FBSB0010-1 ...			1	1
28	bottom hinge	Ref. PDB, FBEL01			1	
29	bottom hinge S	Ref. PDB, FBEL02				1
30	filling piece H timber	Ref. PDB, FBFS			1	1
31	cover cap EL U		FKEU0010-004 ...	FKEU0010-012 ...	1	
32	cover cap EL-S U		FKEL0010-004 ...	FKEL0010-012 ...		1
33	bottom hinge pin diam.6	TBLB0010-1 ...			1	1
34	reb.cor.hinge	Ref. PDB, TBFE81			1	1
35	cover cap FEB rh.		TKFE7011-004 ...	TKFE7011-012 ...	1	1
	cover cap FEB lh.		TKFE7012-004 ...	TKFE7012-012 ...	1	1

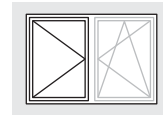

5

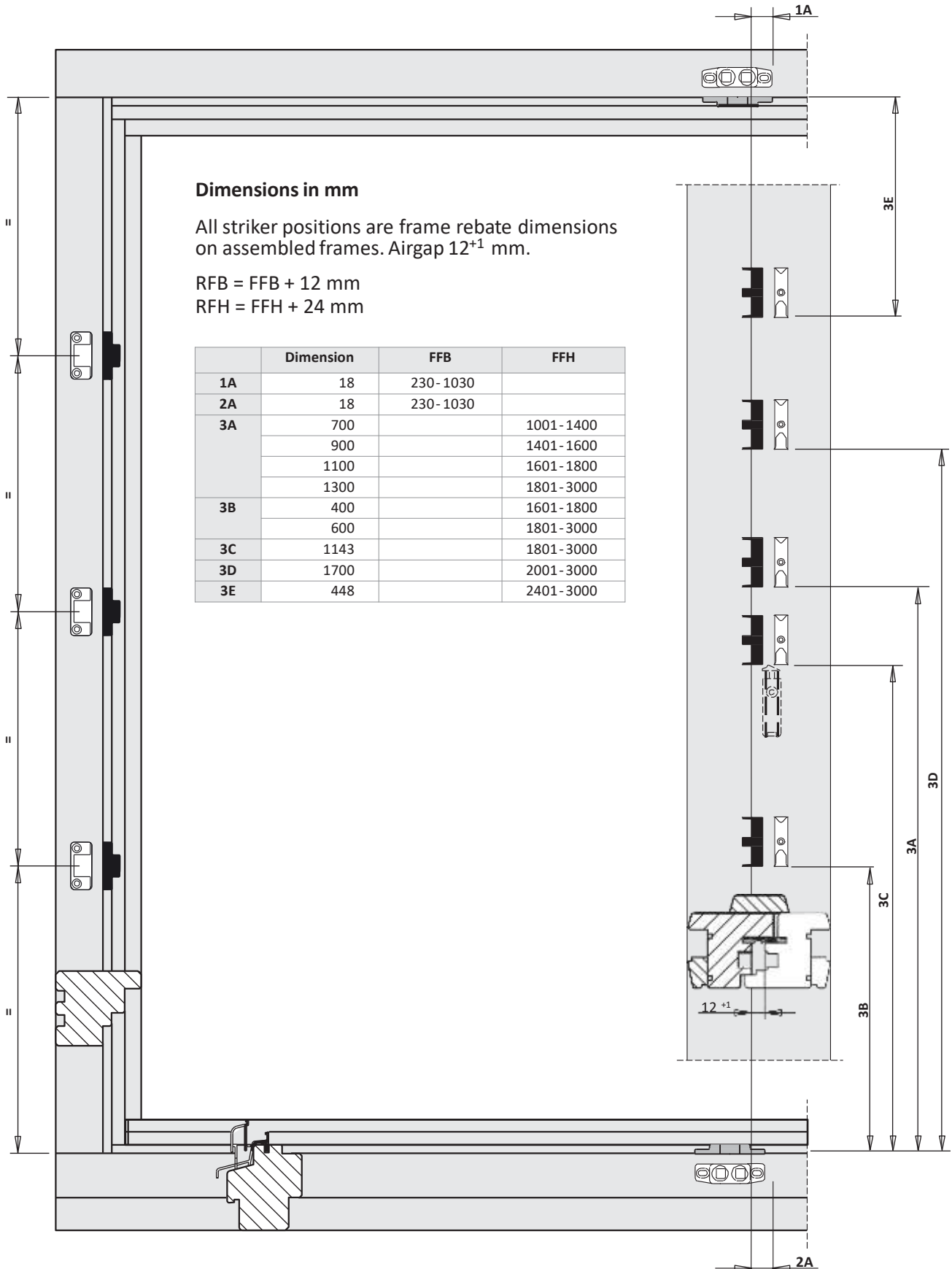

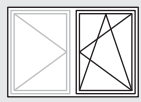

Frame dimensions main sash
2-sash square tilt-turn turn shoot bolt
H12 GK Hinge side Si-line

FAVORIT

GS

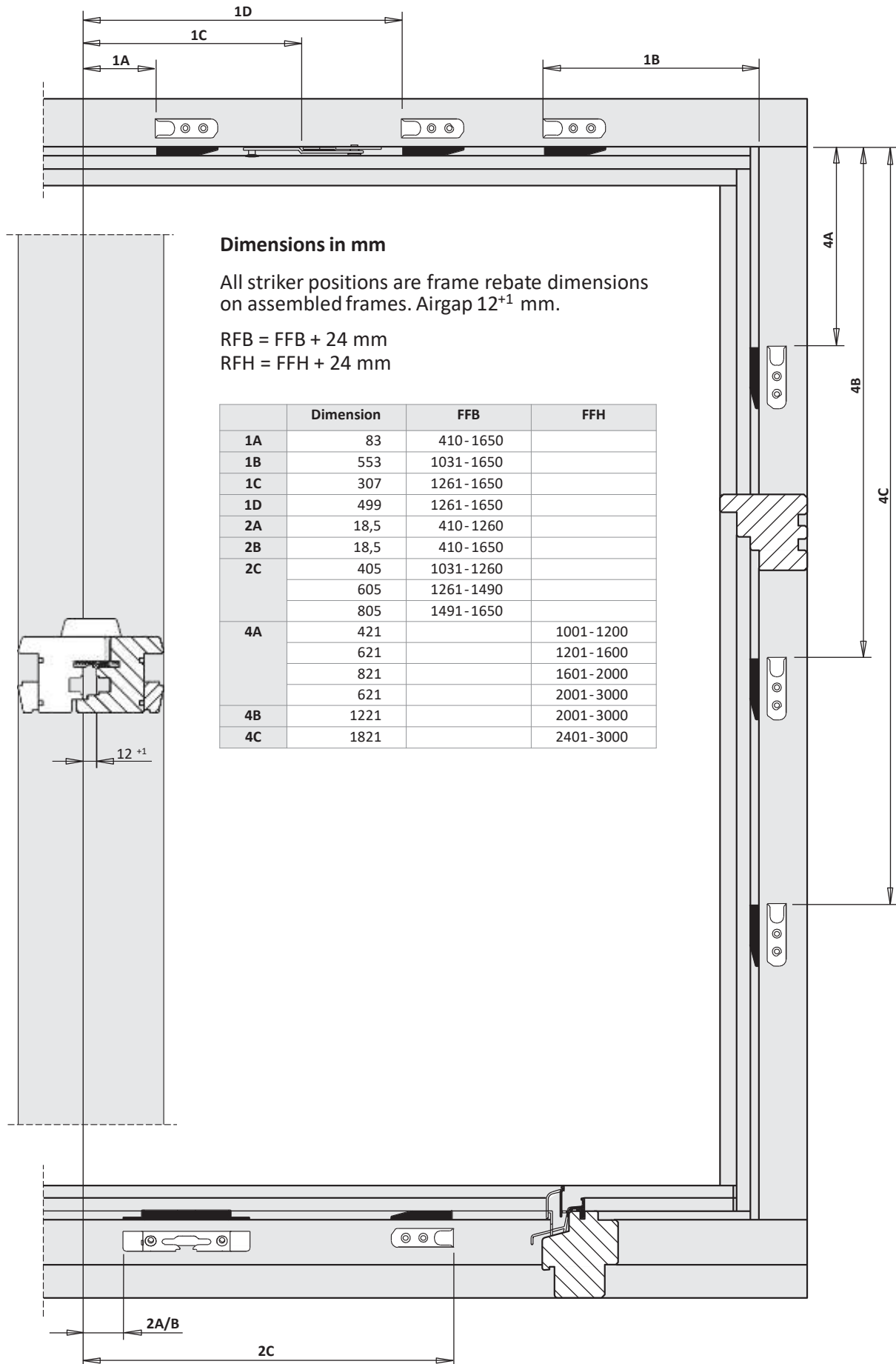

5

FAVORIT

Installation instructions



1-sash square tilt before turn (TBT)

timber 12 mm

basic security

fixed handle position

Hinge side Si-line

surface TS

backset 15 mm

5

Hardware set configuration	
General	Locking-points distance 1000
Stay side	one-piece stay
Bottom	loose sash lift
Locking side	mishandl. device on gear
Hinge side	corner drive BS 2V
Hinge side turning points	loose filling pc I pre-mounted

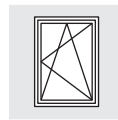

5

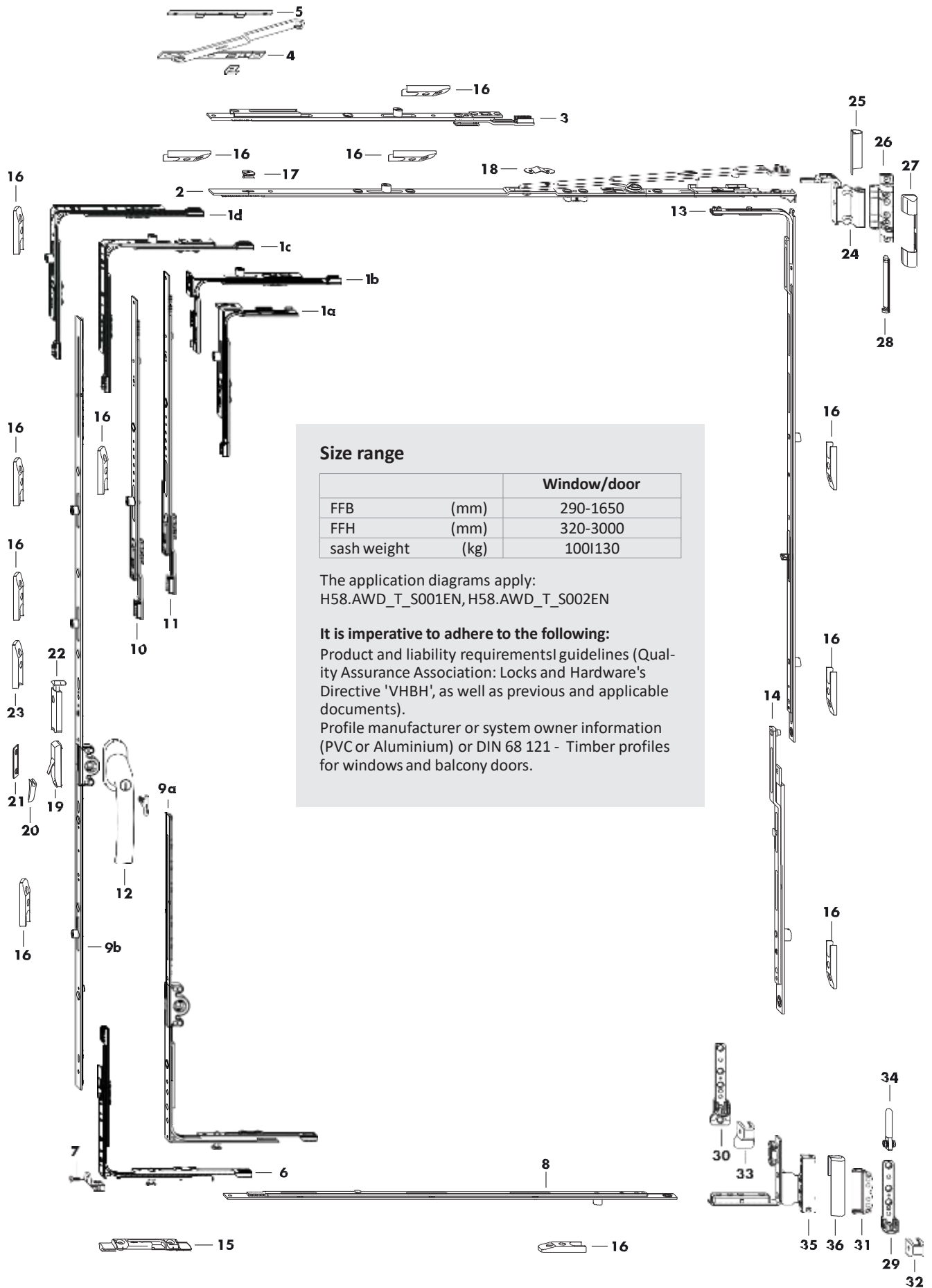

Size range

		Window/door
FFB	(mm)	290-1650
FFH	(mm)	320-3000
sash weight	(kg)	100 130

The application diagrams apply:
H58.AWD_T_S001EN, H58.AWD_T_S002EN

It is imperative to adhere to the following:

Product and liability requirements | guidelines (Quality Assurance Association: Locks and Hardware's Directive 'VHBH', as well as previous and applicable documents).

Profile manufacturer or system owner information (PVC or Aluminium) or DIN 68 121 - Timber profiles for windows and balcony doors.



List of fittings
1-sash square tilt before turn (TBT)
H12 GK Hinge side Si-line

FAVORIT

GS

Pos.	Description	Part number	QTY	FFB	FFH	Dimension G	Number of frame parts / Pos.	
							15	16
1a	corn.drive narrow VSO ..	FEUL0520- ...	1	290- 410	431-3000			1
1b	corn.drive narrow VSO ..	FEUL0520- ...	1	411- 800	320- 430			1
1c	corn.drive VSO ..	FEUL0230- ...	1	411- 1260	431-3000			1
1d	corn.drive VSO ..	FEUL0230- ...	1	1261- 1650	431-3000			1
2	stay 7 TBT sz 30	707357	1	290- 620				
	stay 7 TBT sz 35 MV	707364		621- 800				
	stay 7 TBT sz 50 MV	707371		801- 1030				
	stay 7 TBT sz 55 MV	707388		1031- 1260				1
	stay 7 TBT sz 50 MV	707371		1261- 1490				1
	stay 7 TBT sz 55 MV	707388		1491- 1650				1
3	linkage SIZ TBT FAV 1V	FZOT0100- ...	1	1261- 1650				1
4	additional stay	Ref. PDB, TSZS	1	1261- 1650				
5	packer Z	Ref. PDB, FRUP01	1	1261- 1650				
6	corn.drive FAV VS 1S ..	FEUL0510- ...	1	290- 1650	601- 3000		1	
7	sash lift S-ES	Ref. PDB, FMFH	1	290- 1650				
8	centre lock sz 50	700969	1	1031- 1260				1
	centre lock sz 70	700976		1261- 1490				1
	centre lock sz 90	700983		1491- 1650				1
9a	gear 15 FAV sz 30IG180 S-ES	FGKK4020- ...	1	411- 800	320- 430	180	1	
	gear 15 FAV sz 30IG180 S-ES	FGKK4020- ...		290- 1260	431- 600	180	1	
9b	gear 15 FAV sz 60IG300	FGKK4030- ...	1		601- 800	300		
	gear 15 FAV sz 80IG400 1V	FGKK4050- ...			801- 1000	400		
	gear 15 FAV sz 100IG500 1V	FGKK4060- ...			1001- 1200	500		1
	gear 15 FAV sz 120IG600 1V	FGKK4070- ...			1201- 1400	600		1
	gear 15 FAV sz 140IG700 2V	FGKK4200- ...			1401- 1600	700		1
	gear 15 FAV sz 160IG700 2V 70	FGKK4090- ...			1601- 1800	700		1
	gear 15 FAV sz 180IG1000 2V	FGKK4220- ...			1801- 2000	1000		2
	gear 15 FAV sz 200IG1000 3V	FGKK4230- ...			2001- 3000	1000		3
10	linkage FAV sz 200 A0767	FZSZ0120- ...	1		2201- 2400			
	linkage FAV sz 400 1V	FZSZ0110- ...			2401- 3000			1
11	linkage FAV sz 200 A0767	FZSZ0120- ...	1		2601- 2800			
	linkage FAV sz 400 A0767	FZSZ0130- ...			2801- 3000			
12	handle Globe TBT lockable	Ref.access. ZHGT	1		320- 3000			
13	corn.drive VSU BS sz 50 1V ..	FEUL2070- ...	1		1001- 1200			1
	corn.drive VSU BS sz 70 1V ..	FEUL2080- ...			1201- 1600			1
	corn.drive VSU BS sz 90 1V ..	FEUL2090- ...			1601- 2000			1
	corn.drive BS sz 130 2V ..	FEUL2630- ...			2001- 3000			2
14	MV extension sz 60	700952	1		2401- 3000			1
15	tilt lock bear. S-ES FH TBT	Ref. PDB, FRKB						
16	striker plate 56	Ref. PDB, FRSB						
on request								
17	location piece ..	702543	1					
18	tilt restrictor ..	805701	1		320- 800			
19	mishandling device FAV.	FFBS0110- ...	1					
20	pressure piece	Ref. PDB, TFFD	1					
21	stop	Ref. PDB, FRZF01	1					
22	snapper switchable rh.	TFST0011- ...	1		1801- 3000			
	snapper switchable lh.	TFST0012- ...			1801- 3000			
23	frame part snapper	Ref. PDB, TRST	1		1801- 3000			



Pos.	Description	Hinge side turning points			required as per sash weight	
		surface TS	Part number		100 kg	130 kg
			RAL9016	RAL8022		
24	stay hinge	Ref. PDB, FBWB			1	1
25	cover cap W timber		FKWB0020-004 ...	FKWB0020-012 ...	1	1
26	top hinge S	Ref. PDB, FBSL02			1	1
27	cover cap S		FKSL0010-004 ...	FKSL0010-012 ...	1	1
28	top hinge pin diam.6	FBSB0010-1 ...			1	1
29	bottom hinge	Ref. PDB, FBEL01			1	
30	bottom hinge S	Ref. PDB, FBEL02				1
31	filling piece H timber	Ref. PDB, FBFS			1	1
32	cover cap EL U		FKEU0010-004 ...	FKEU0010-012 ...	1	
33	cover cap EL-S U		FKEL0010-004 ...	FKEL0010-012 ...		1
34	bottom hinge pin diam.6	TBLB0010-1 ...			1	1
35	reb.cor.hinge	Ref. PDB, TBFE81			1	1
36	cover cap FEB rh.		TKFE7011-004 ...	TKFE7011-012 ...	1	1
	cover cap FEB lh.		TKFE7012-004 ...	TKFE7012-012 ...	1	1



Frame dimensions

1-sash square tilt before turn (TBT)
H12 GK Hinge side Si-line

FAVORIT

GS

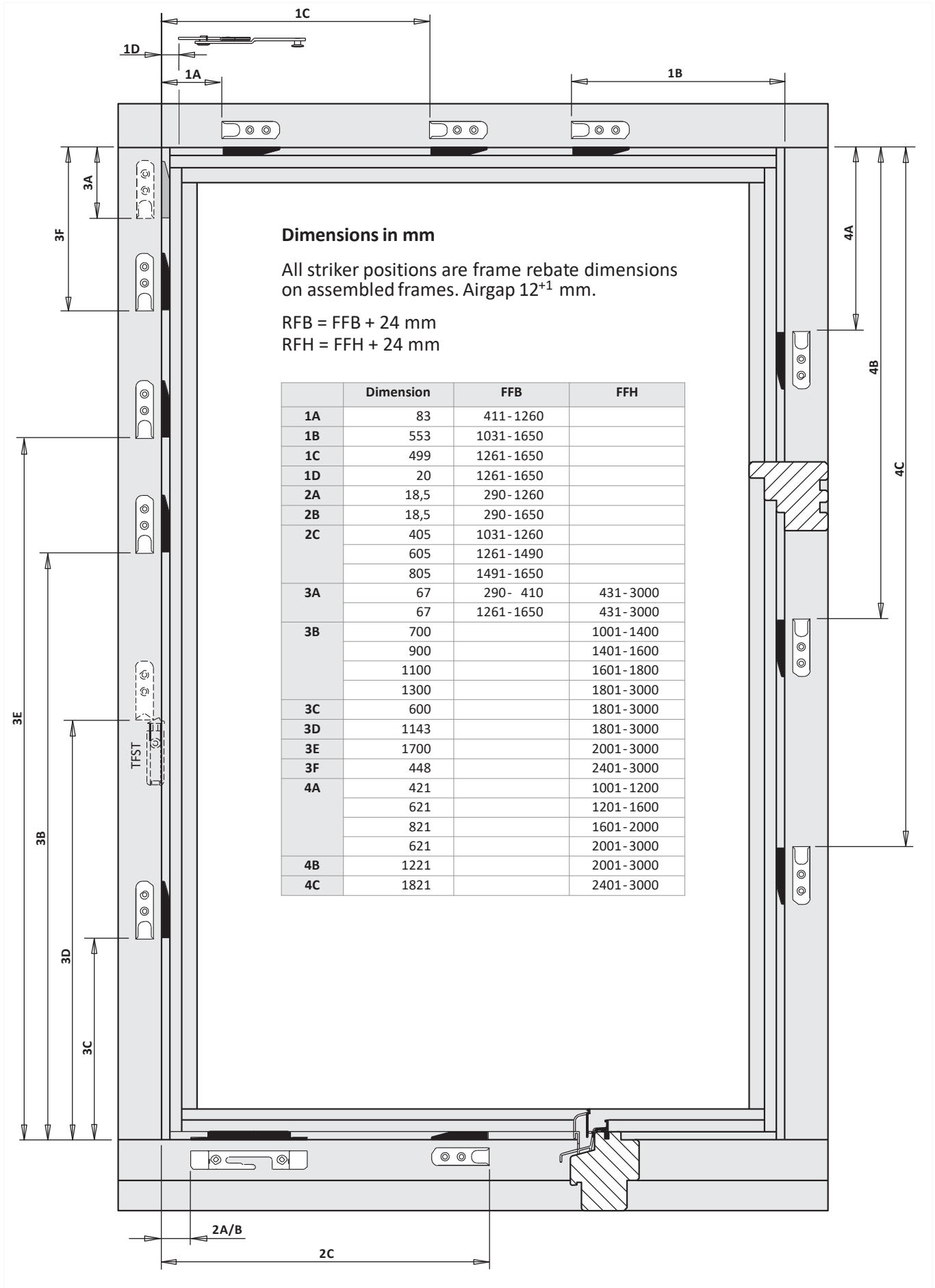

FAVORIT

Installation instructions



1-sash square tilt-turn

timber 12 mm

3-Punkt Sicherheit

fixed handle position

Hinge side Si-line

surface TS

backset 15 mm

5

Hardware set configuration

Hardware set configuration	
General	Locking-points distance 1000
Stay side	one-piece stay
Bottom	loose sash lift
Locking side	mishandl. device on gear
Hinge side	corner drive 1S 2V
Hinge side turning points	loose filling pc I pre-mounted

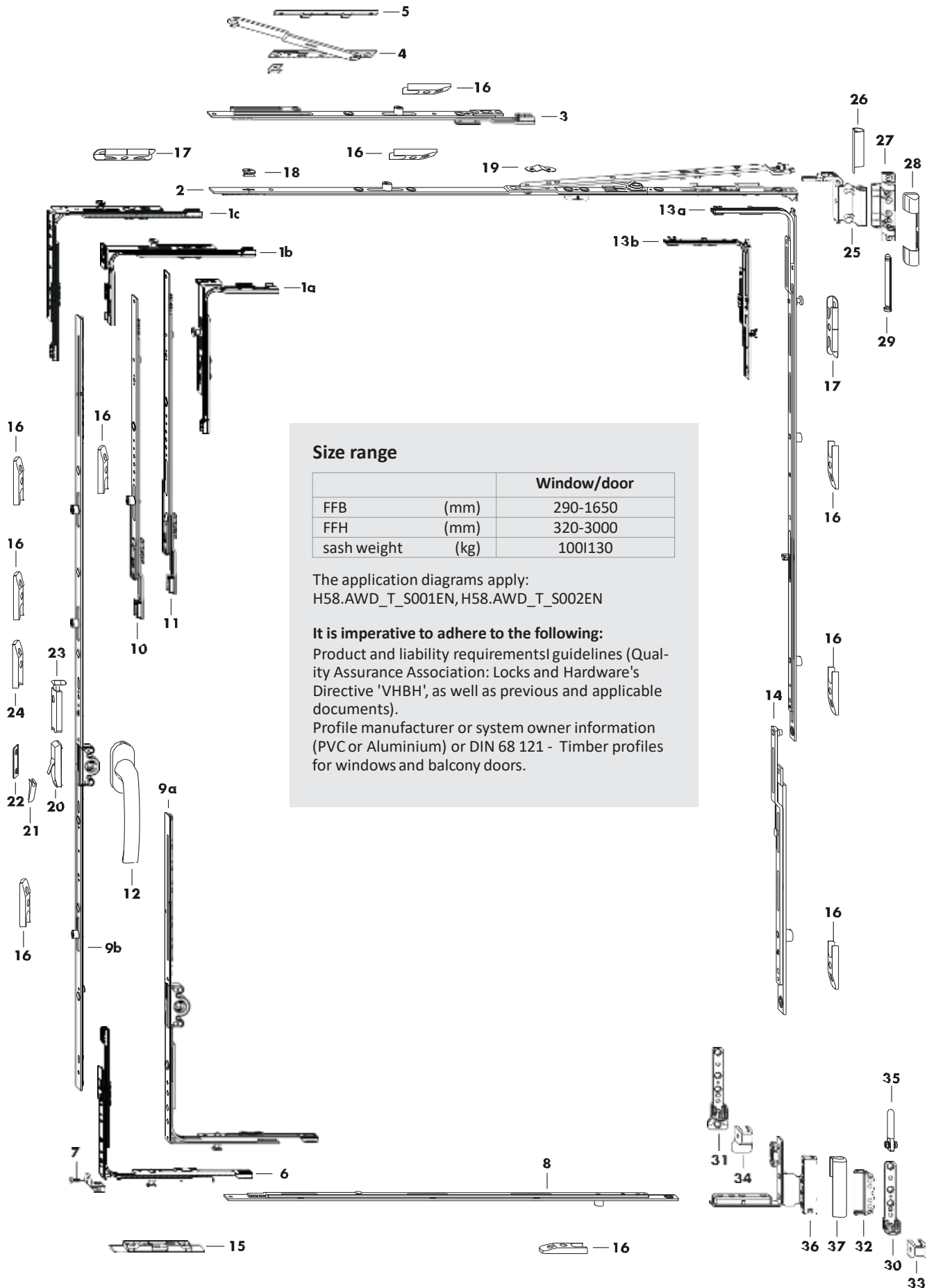

Size range

		Window/door
FFB	(mm)	290-1650
FFH	(mm)	320-3000
sash weight	(kg)	100 130

The application diagrams apply:
H58.AWD_T_S001EN, H58.AWD_T_S002EN

It is imperative to adhere to the following:
Product and liability requirements guidelines (Quality Assurance Association: Locks and Hardware's Directive 'VHBH', as well as previous and applicable documents).
Profile manufacturer or system owner information (PVC or Aluminium) or DIN 68 121 - Timber profiles for windows and balcony doors.



List of fittings
1-sash square tilt-turn
H12 GK Hinge side Si-line

FAVORIT

3P

Pos.	Description	Part number	QTY	FFB	FFH	Dimension G	Number of frame parts / Pos.		
							15	16	17
1a	corn.drive FAV VSO narrow 1S ..	FEUL0530- ...	1	290- 410	431-3000				1
1b	corn.drive FAV VSO narrow 1S ..	FEUL0530- ...	1	411- 800	320- 430				1
1c	corn.drive FAV VS 1S ..	FEUL0510- ...	1	411- 1650	431-3000				1
2	stay 7 sz 30	707302	1	290- 620					
	stay 7 sz 35 MV	707319		621- 800					
	stay 7 sz 50 MV	707326		801- 1030					
	stay 7 sz 55 MV	707333		1031- 1260				1	
	stay 7 sz 50 MV	707326		1261- 1490				1	
	stay 7 sz 55 MV	707333		1491- 1650				1	
3	linkage SIZ FAV 1V	FZOK0100- ...	1	1261- 1650				1	
4	additional stay	Ref. PDB, TSZS	1	1261- 1650					
5	packer Z	Ref. PDB, FRUP01	1	1261- 1650					
6	corn.drive FAV VS 1S ..	FEUL0510- ...	1	290- 1650	601-3000		1		
7	sash lift S-ES	Ref. PDB, FMFH	1	290- 1650					
8	centre lock sz 50	700969	1	1031- 1260				1	
	centre lock sz 70	700976		1261- 1490				1	
	centre lock sz 90	700983		1491- 1650				1	
9a	gear 15 FAV sz 30IG180 S-ES	FGKK4020- ...	1	411- 800	320- 430	180	1		
	gear 15 FAV sz 30IG180 S-ES	FGKK4020- ...		290- 1260	431- 600	180	1		
9b	gear 15 FAV sz 60IG300	FGKK4030- ...	1		601- 800	300			
	gear 15 FAV sz 80IG400 1V	FGKK4050- ...			801- 1000	400			
	gear 15 FAV sz 100IG500 1V	FGKK4060- ...			1001- 1200	500		1	
	gear 15 FAV sz 120IG600 1V	FGKK4070- ...			1201- 1400	600		1	
	gear 15 FAV sz 140IG700 2V	FGKK4200- ...			1401- 1600	700		1	
	gear 15 FAV sz 160IG700 2V 70	FGKK4090- ...			1601- 1800	700		1	
	gear 15 FAV sz 180IG1000 2V	FGKK4220- ...			1801- 2000	1000		2	
	gear 15 FAV sz 200IG1000 3V	FGKK4230- ...			2001- 3000	1000		3	
10	linkage FAV sz 200 A0767	FZSZ0120- ...	1		2201- 2400				
	linkage FAV sz 400 1V	FZSZ0110- ...			2401- 3000			1	
11	linkage FAV sz 200 A0767	FZSZ0120- ...	1		2601- 2800				
	linkage FAV sz 400 A0767	FZSZ0130- ...			2801- 3000				
12	handle Globe	Ref.access. ZHGS	1		320- 3000				
13a	corn.drive BS sz 20 1S ..	FEUL2100- ...	1		320- 1000				1
13b	corn.drive BS sz 50 1S 1V ..	FEUL2110- ...	1		1001- 1200			1	1
	corn.drive BS sz 70 1S 1V ..	FEUL2120- ...			1201- 1600			1	1
	corn.drive BS sz 90 1S 1V ..	FEUL2130- ...			1601- 2000			1	1
	corn.drive BS sz 130 1S 2V ..	FEUL2140- ...			2001- 3000			2	1
14	MV extension sz 60	700952	1		2401- 3000			1	
15	tilt lock bear. S-ES FH	Ref. PDB, FRKA							
16	striker plate 56	Ref. PDB, FRSB							
17	striker plate S-RS	Ref. PDB, TRSK							
on request									
18	location piece ..	702543	1						
19	tilt restrictor ..	805701	1		320- 800				
20	mishandling device FAV.	FFBS0110- ...	1						
21	pressure piece	Ref. PDB, TFFD	1						
22	stop	Ref. PDB, FRZF01	1						
23	snapper switchable rh.	TFST0011- ...	1		1801- 3000				
	snapper switchable lh.	TFST0012- ...			1801- 3000				
24	frame part snapper	Ref. PDB, TRST	1		1801- 3000				



Pos.	Description	Hinge side turning points			required as per sash weight	
		surface TS	Part number		100 kg	130 kg
			RAL9016	RAL8022		
25	stay hinge	Ref. PDB, FBWB			1	1
26	cover cap W timber		FKWB0020-004 ...	FKWB0020-012 ...	1	1
27	top hinge S	Ref. PDB, FBSL02			1	1
28	cover cap S		FKSL0010-004 ...	FKSL0010-012 ...	1	1
29	top hinge pin diam.6	FBSB0010-1 ...			1	1
30	bottom hinge	Ref. PDB, FBEL01			1	
31	bottom hinge S	Ref. PDB, FBEL02				1
32	filling piece H timber	Ref. PDB, FBFS			1	1
33	cover cap EL U		FKEU0010-004 ...	FKEU0010-012 ...	1	
34	cover cap EL-S U		FKEL0010-004 ...	FKEL0010-012 ...		1
35	bottom hinge pin diam.6	TBLB0010-1 ...			1	1
36	reb.cor.hinge	Ref. PDB, TBFE81			1	1
37	cover cap FEB rh.		TKFE7011-004 ...	TKFE7011-012 ...	1	1
	cover cap FEB lh.		TKFE7012-004 ...	TKFE7012-012 ...	1	1

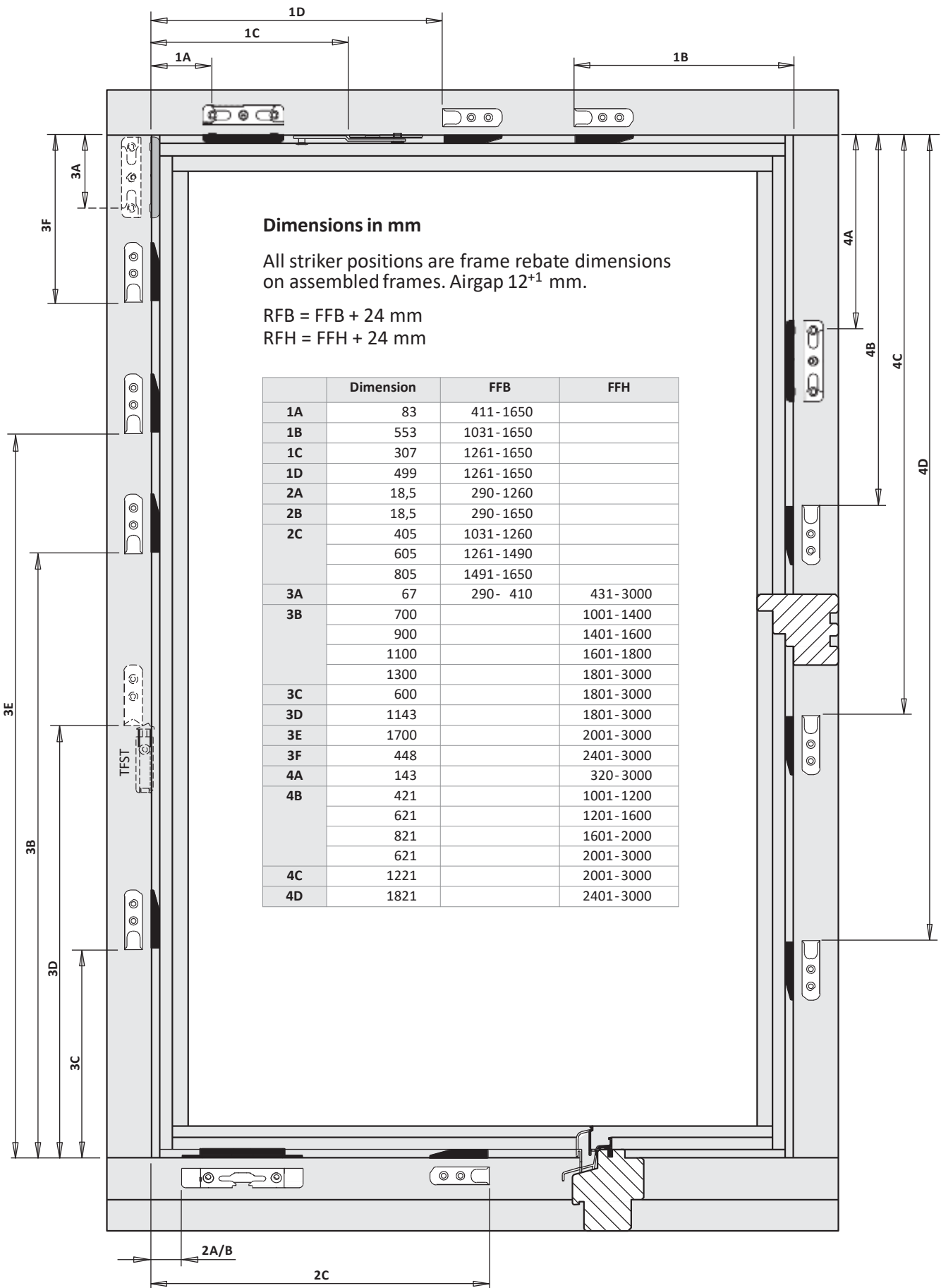

FAVORIT

Installation instructions

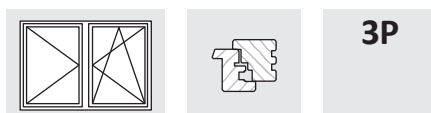

2-sash square tilt-turn/turn DSG gear

timber 12 mm

3-Punkt Sicherheit

fixed handle position

Hinge side Si-line

surface TS

backset 15 mm

5

Hardware set configuration	
General	Locking-points distance 1000
Stay side	one-piece stay
Bottom	loose sash lift
Locking side	mishandl. device on gear
Hinge side	corner drive 1S 2V
Hinge side turning points	loose filling pc I pre-mounted

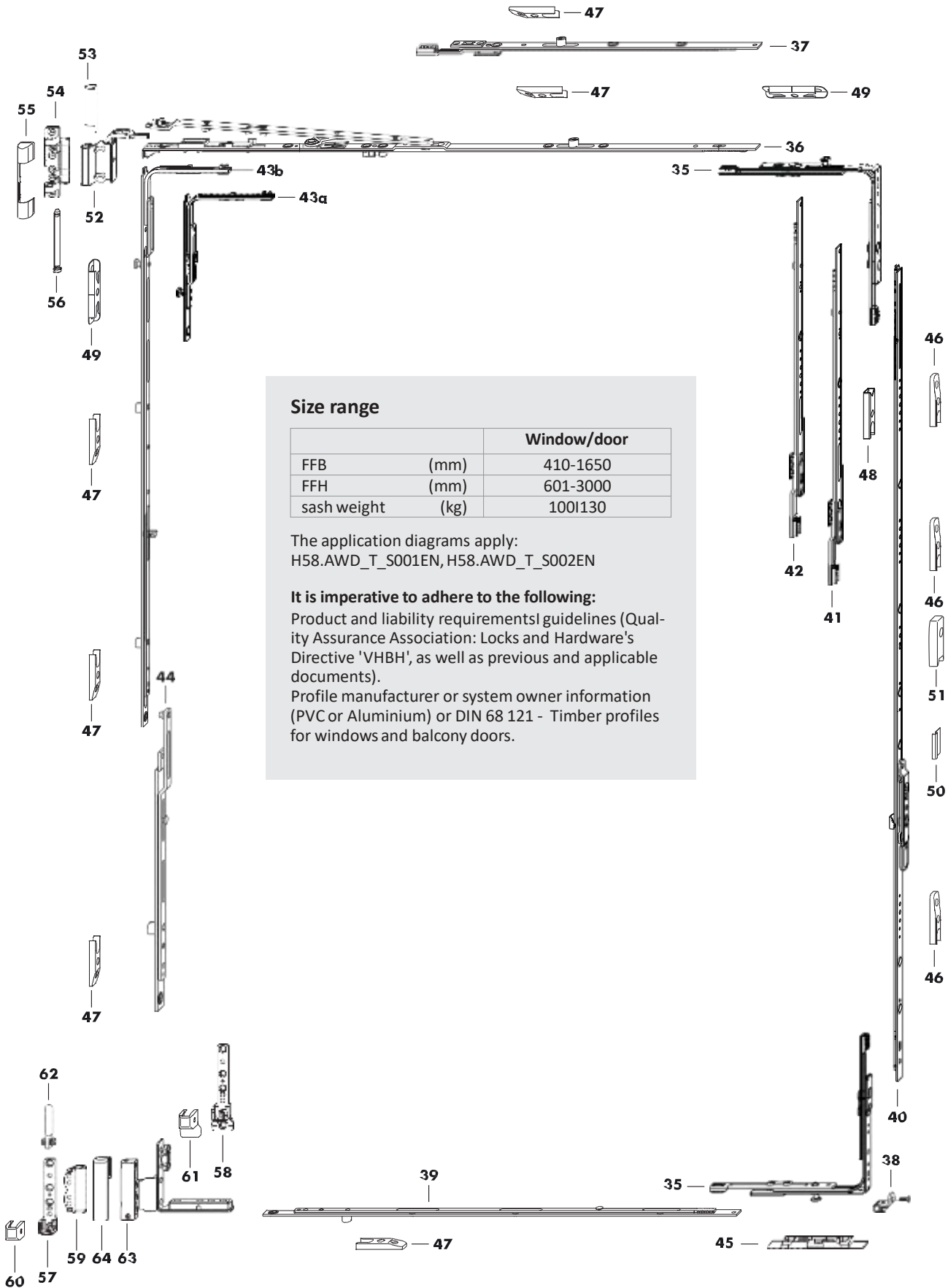
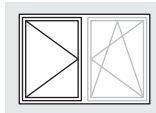

Size range

		Window/door
FFB	(mm)	410-1650
FFH	(mm)	601-3000
sash weight	(kg)	100 130

The application diagrams apply:
H58.AWD_T_S001EN, H58.AWD_T_S002EN

It is imperative to adhere to the following:
Product and liability requirements | guidelines (Quality Assurance Association: Locks and Hardware's Directive 'VHBH', as well as previous and applicable documents).
Profile manufacturer or system owner information (PVC or Aluminium) or DIN 68 121 - Timber profiles for windows and balcony doors.

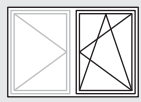

hardware layout main sash

2-sash square tilt-turn DSG gear
H12 GK Hinge side Si-line

FAVORIT

3P

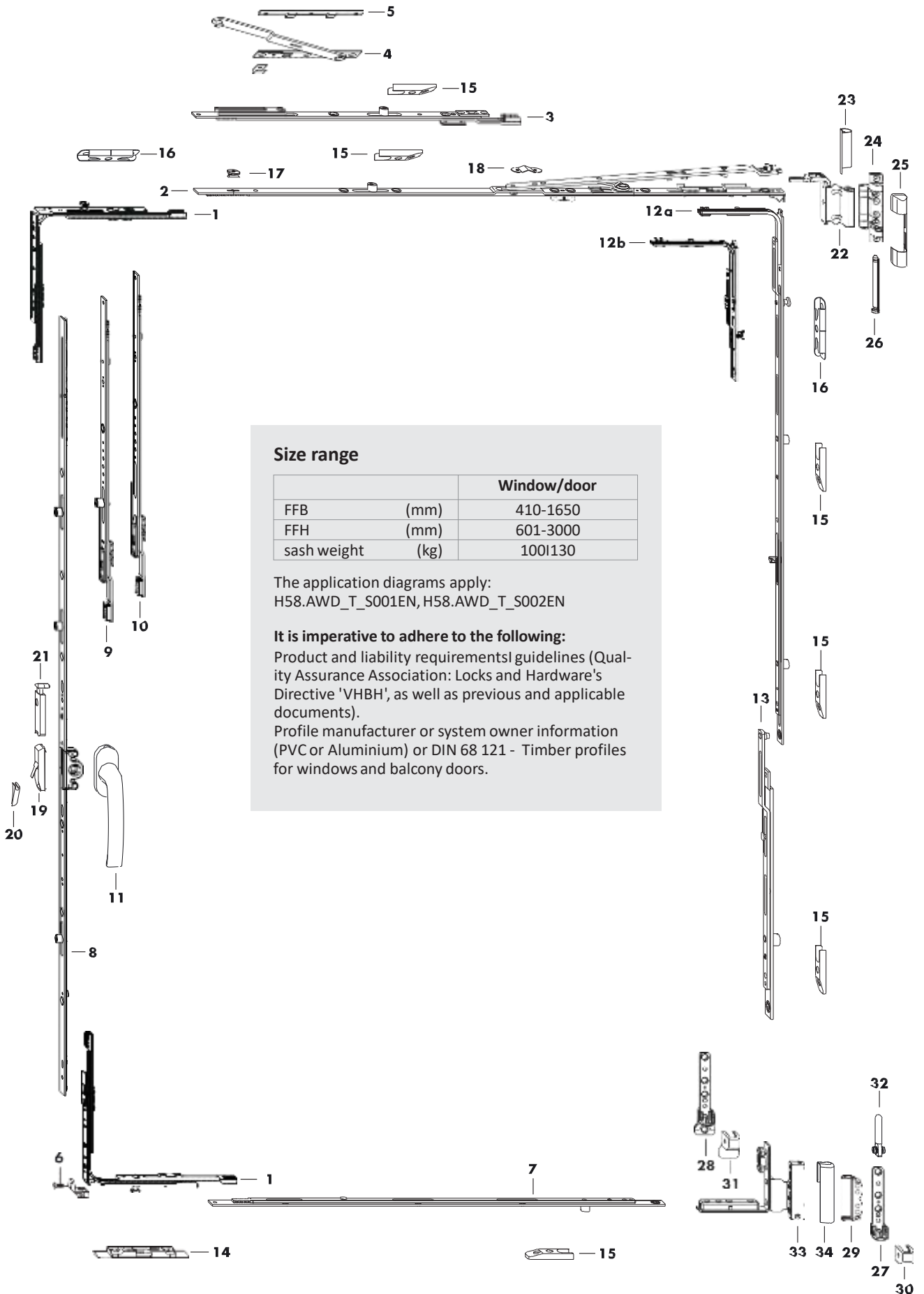

Size range

		Window/door
FFB	(mm)	410-1650
FFH	(mm)	601-3000
sash weight	(kg)	100 130

The application diagrams apply:
H58.AWD_T_S001EN, H58.AWD_T_S002EN

It is imperative to adhere to the following:

Product and liability requirements | guidelines (Quality Assurance Association: Locks and Hardware's Directive 'VHBH', as well as previous and applicable documents).

Profile manufacturer or system owner information (PVC or Aluminium) or DIN 68 121 - Timber profiles for windows and balcony doors.

List of fittings slave sash

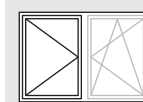
2-sash square tilt-turn/turn DSG gear
H12 GK Hinge side Si-line

Pos.	Description	Part number	QTY	FFB	FFH	Dimension G	Number of frame parts / Pos.				
							In the main sash	45	46	47	48
35	corn.drive FAV VS 1S ..	FEUL0510- ...	2	410- 1650			1				1
36	stay 7 sz 30	707302	1	410- 620							
	stay 7 sz 35 MV	707319		621- 800							
	stay 7 sz 50 MV	707326		801- 1030							
	stay 7 sz 55 MV	707333		1031- 1260						1	
	stay 7 sz 50 MV	707326		1261- 1490						1	
	stay 7 sz 55 MV	707333		1491- 1650						1	
37	linkage sz 460 MV	713266	1	1261- 1650					1		
38	sash lift S-ES	Ref. PDB, FMFH	1	410- 1650							
39	centre lock sz 50	700969	1	1031- 1260					1		
	centre lock sz 70	700976		1261- 1490					1		
	centre lock sz 90	700983		1491- 1650					1		
40	s.sash gear16 FAV 60I300	FGKS4030- ...	1		601- 800	300					
	s.sash gear16 FAV 80I400 1SB	FGKS4050- ...		801- 1000	400						
	s.sash gear16 FAV 100I500 1SB	FGKS4060- ...		1001- 1200	500	1					
	s.sash gear16 FAV 120I600 1SB	FGKS4070- ...		1201- 1400	600	1					
	s.sash gear16 FAV 140I700 2SB	FGKS4290- ...		1401- 1600	700	1					
	s.sash gear16 FAV 160I700 2SB	FGKS4330- ...		1601- 1800	700	1					
	s.sash gear16 FAV 180I1000 2SB	FGKS4100- ...		1801- 2000	1000	1					
	s.sash gear16 FAV 200I1000 3SB	FGKS4280- ...		2001- 3000	1000	1					
41	linkage FAV sz 200 A0767	FZSZ0120- ...	1		2201- 2400						
	linkage FAV sz 400 A0767	FZSZ0130- ...		2401- 3000					1		
42	linkage FAV sz 200 A0767	FZSZ0120- ...	1		2601- 2800					1	
	linkage FAV sz 400 A0767	FZSZ0130- ...		2801- 3000							
43a	corn.drive BS sz 20 1S ..	FEUL2100- ...	1		601- 1000					1	
43b	corn.drive BS sz 50 1S 1V ..	FEUL2110- ...	1		1001- 1200				1	1	
	corn.drive BS sz 70 1S 1V ..	FEUL2120- ...		1201- 1600				1	1		
	corn.drive BS sz 90 1S 1V ..	FEUL2130- ...		1601- 2000				1	1		
	corn.drive BS sz 130 1S 2V ..	FEUL2140- ...		2001- 3000				2	1		
44	MV extension sz 60	700952	1		2401- 3000			1			
45	tilt lock bear. S-ES FH	Ref. PDB, FRKA									
46	striker plate f. gear MV	Ref. PDB, FRSA02									
47	striker plate 56	Ref. PDB, FRSB									
48	striker plate 56 A0767	TRSB0020- ...									
49	striker plate S-RS	Ref. PDB, TRSK									
on request											
50	stop	Ref. PDB, FRZF04	1		801- 3000						
51	striker snapper A0767	TRST0010- ...	1		1801- 3000						

Pos.	Description	Hinge side turning points				required as per sash weight	
		Part number			100 kg	130 kg	
		surface TS	RAL9016	RAL8022			
52	stay hinge	Ref. PDB, FBWB			1	1	
53	cover cap W timber		FKWB0020-004 ...	FKWB0020-012 ...	1	1	
54	top hinge S	Ref. PDB, FBSL02			1	1	
55	cover cap S		FKSL0010-004 ...	FKSL0010-012 ...	1	1	
56	top hinge pin diam.6	FBSB0010-1 ...			1	1	
57	bottom hinge	Ref. PDB, FBEL01			1		
58	bottom hinge S	Ref. PDB, FBEL02				1	
59	filling piece H timber	Ref. PDB, FBFS			1	1	
60	cover cap EL U		FKEU0010-004 ...	FKEU0010-012 ...	1		
61	cover cap EL-S U		FKEL0010-004 ...	FKEL0010-012 ...		1	
62	bottom hinge pin diam.6	TBLB0010-1 ...			1	1	
63	reb.cor.hinge	Ref. PDB, TBFE81			1	1	
64	cover cap FEB rh.		TKFE7011-004 ...	TKFE7011-012 ...	1	1	
	cover cap FEB lh.		TKFE7012-004 ...	TKFE7012-012 ...	1	1	

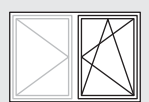

List of fittings main sash

2-sash square tilt-turn turn DSG gear
H12 GK Hinge side Si-line

FAVORIT

3P

Pos.	Description	Part number	QTY	FFB	FFH	Dimension G	Number of frame parts / Pos.		
							14	15	16
1	corn.drive FAV VS 1S ..	FEUL0510- ...	2	410- 1650			1		1
2	stay 7 sz 30	707302	1	410- 620					
	stay 7 sz 35 MV	707319		621- 800					
	stay 7 sz 50 MV	707326		801- 1030					
	stay 7 sz 55 MV	707333		1031- 1260				1	
	stay 7 sz 50 MV	707326		1261- 1490				1	
	stay 7 sz 55 MV	707333		1491- 1650				1	
3	linkage SIZ FAV 1V	FZOK0100- ...	1	1261- 1650				1	
4	additional stay	Ref. PDB, TSZS	1	1261- 1650					
5	packer Z	Ref. PDB, FRUP01	1	1261- 1650					
6	sash lift S-ES	Ref. PDB, FMFH	1	410- 1650					
7	centre lock sz 50	700969	1	1031- 1260				1	
	centre lock sz 70	700976		1261- 1490				1	
	centre lock sz 90	700983		1491- 1650				1	
8	gear 15 FAV sz 60IG300	FGKK4030- ...	1		601- 800	300			
	gear 15 FAV sz 80IG400 1V	FGKK4050- ...			801- 1000	400			
	gear 15 FAV sz 100IG500 1V	FGKK4060- ...			1001- 1200	500			
	gear 15 FAV sz 120IG600 1V	FGKK4070- ...			1201- 1400	600			
	gear 15 FAV sz 140IG700 2V	FGKK4200- ...			1401- 1600	700			
	gear 15 FAV sz 160IG700 2V 70	FGKK4090- ...			1601- 1800	700			
	gear 15 FAV sz 180IG1000 2V	FGKK4220- ...			1801- 2000	1000			
	gear 15 FAV sz 200IG1000 3V	FGKK4230- ...			2001- 3000	1000			
9	linkage FAV sz 200 A0767	FZSZ0120- ...	1		2201- 2400				
	linkage FAV sz 400 1V	FZSZ0110- ...			2401- 3000				
10	linkage FAV sz 200 A0767	FZSZ0120- ...	1		2601- 2800				
	linkage FAV sz 400 A0767	FZSZ0130- ...			2801- 3000				
11	handle Globe	Ref.access. ZHGS	1		601- 3000				
12a	corn.drive BS sz 20 1S ..	FEUL2100- ...	1		601- 1000				1
12b	corn.drive BS sz 50 1S 1V ..	FEUL2110- ...	1		1001- 1200			1	1
	corn.drive BS sz 70 1S 1V ..	FEUL2120- ...			1201- 1600			1	1
	corn.drive BS sz 90 1S 1V ..	FEUL2130- ...			1601- 2000			1	1
	corn.drive BS sz 130 1S 2V ..	FEUL2140- ...			2001- 3000			2	1
13	MV extension sz 60	700952	1		2401- 3000			1	
14	tilt lock bear. S-ES FH	Ref. PDB, FRKA							
15	striker plate 56	Ref. PDB, FRSB							
16	striker plate S-RS	Ref. PDB, TRSK							
on request									
17	location piece ..	702543	1						
18	tilt restrictor ..	805701	1		601- 800				
19	mishandling device FAV.	FFBS0110- ...	1		801- 3000				
20	pressure piece	Ref. PDB, TFFD	1		801- 3000				
21	snapper switchable rh.	TFST0011- ...	1		1801- 3000				
	snapper switchable lh.	TFST0012- ...			1801- 3000				

Hinge side turning points						
Pos.	Description	Part number			required as per sash weight	
		surface TS	RAL9016	RAL8022	100 kg	130 kg
22	stay hinge	Ref. PDB, FBWB			1	1
23	cover cap W timber		FKWB0020-004 ...	FKWB0020-012 ...	1	1
24	top hinge S	Ref. PDB, FBLS02			1	1
25	cover cap S		FKSL0010-004 ...	FKSL0010-012 ...	1	1
26	top hinge pin diam.6	FBSB0010-1 ...			1	1
27	bottom hinge	Ref. PDB, FBEL01			1	
28	bottom hinge S	Ref. PDB, FBEL02				1
29	filling piece H timber	Ref. PDB, FBFS			1	1
30	cover cap EL U		FKEU0010-004 ...	FKEU0010-012 ...	1	
31	cover cap EL-S U		FKEL0010-004 ...	FKEL0010-012 ...		1
32	bottom hinge pin diam.6	TBLB0010-1 ...			1	1
33	reb.cor.hinge	Ref. PDB, TBFE81			1	1
34	cover cap FEB rh.		TKFE7011-004 ...	TKFE7011-012 ...	1	1
	cover cap FEB lh.		TKFE7012-004 ...	TKFE7012-012 ...	1	1

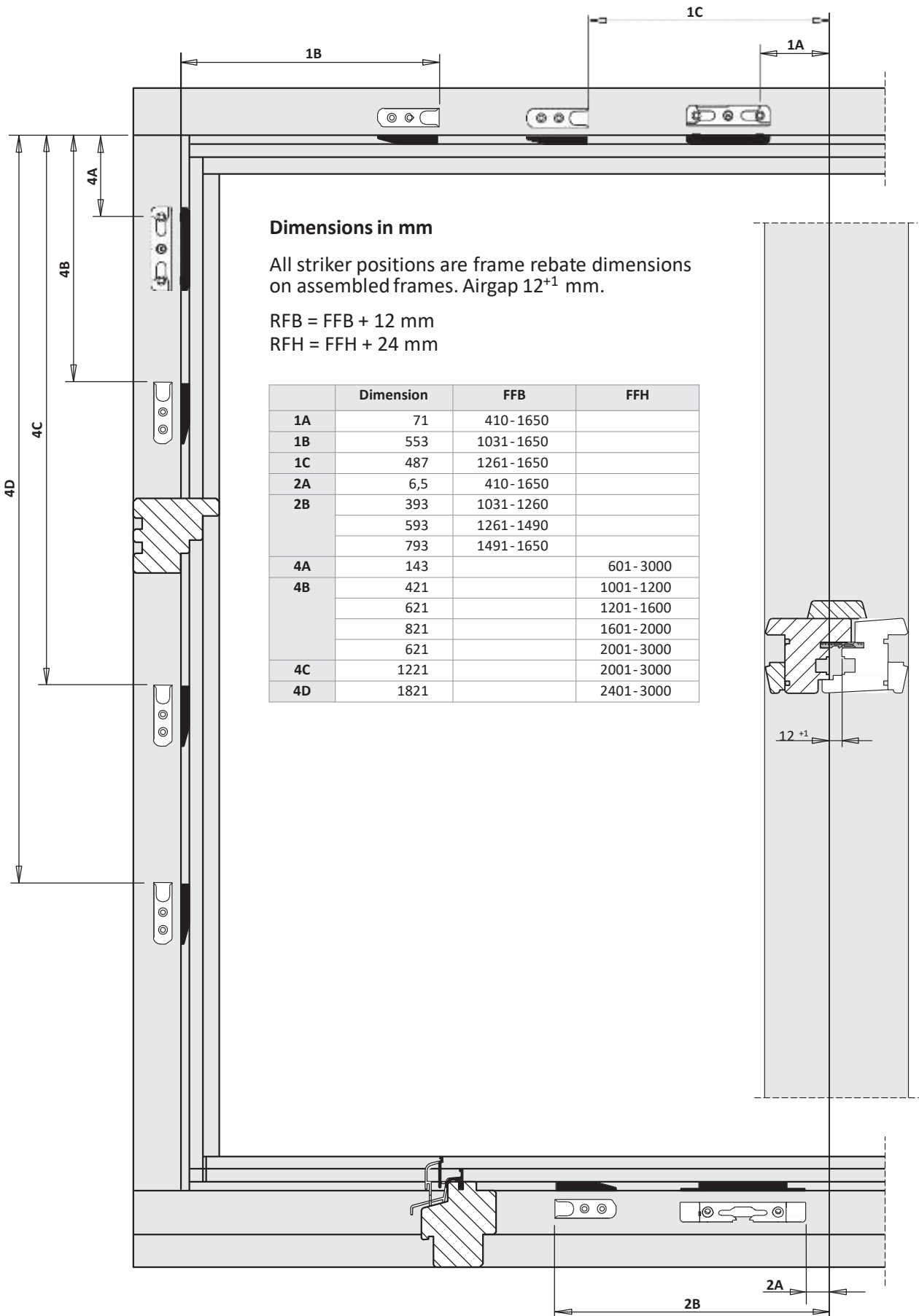
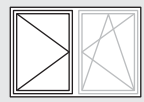

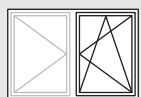

Frame dimensions main sash
 2-sash square tilt-turn turn DSG gear
 H12 GK Hinge side Si-line

FAVORIT

3P

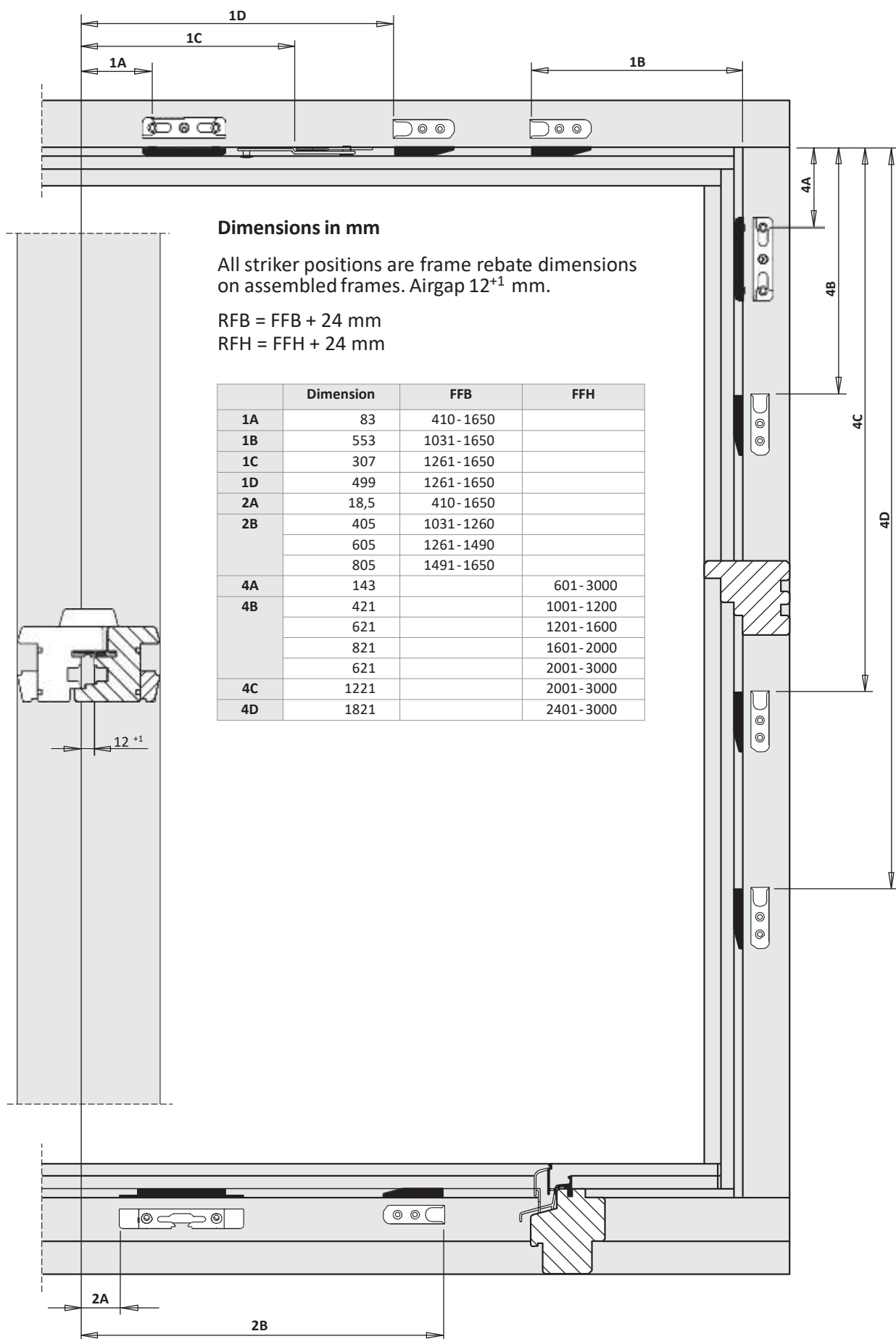

5

FAVORIT

Installation instructions



1-sash square tilt before turn (TBT)

timber 12 mm

3-Punkt Sicherheit

fixed handle position

Hinge side Si-line

surface TS

backset 15 mm

5

Hardware set configuration	
General	Locking-points distance 1000
Stay side	one-piece stay
Bottom	loose sash lift
Locking side	mishandl. device on gear
Hinge side	corner drive 1S 2V
Hinge side turning points	loose filling pc I pre-mounted

hardware layout

1-sash square tilt before turn (TBT)
H12 GK Hinge side Si-line

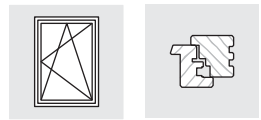

5

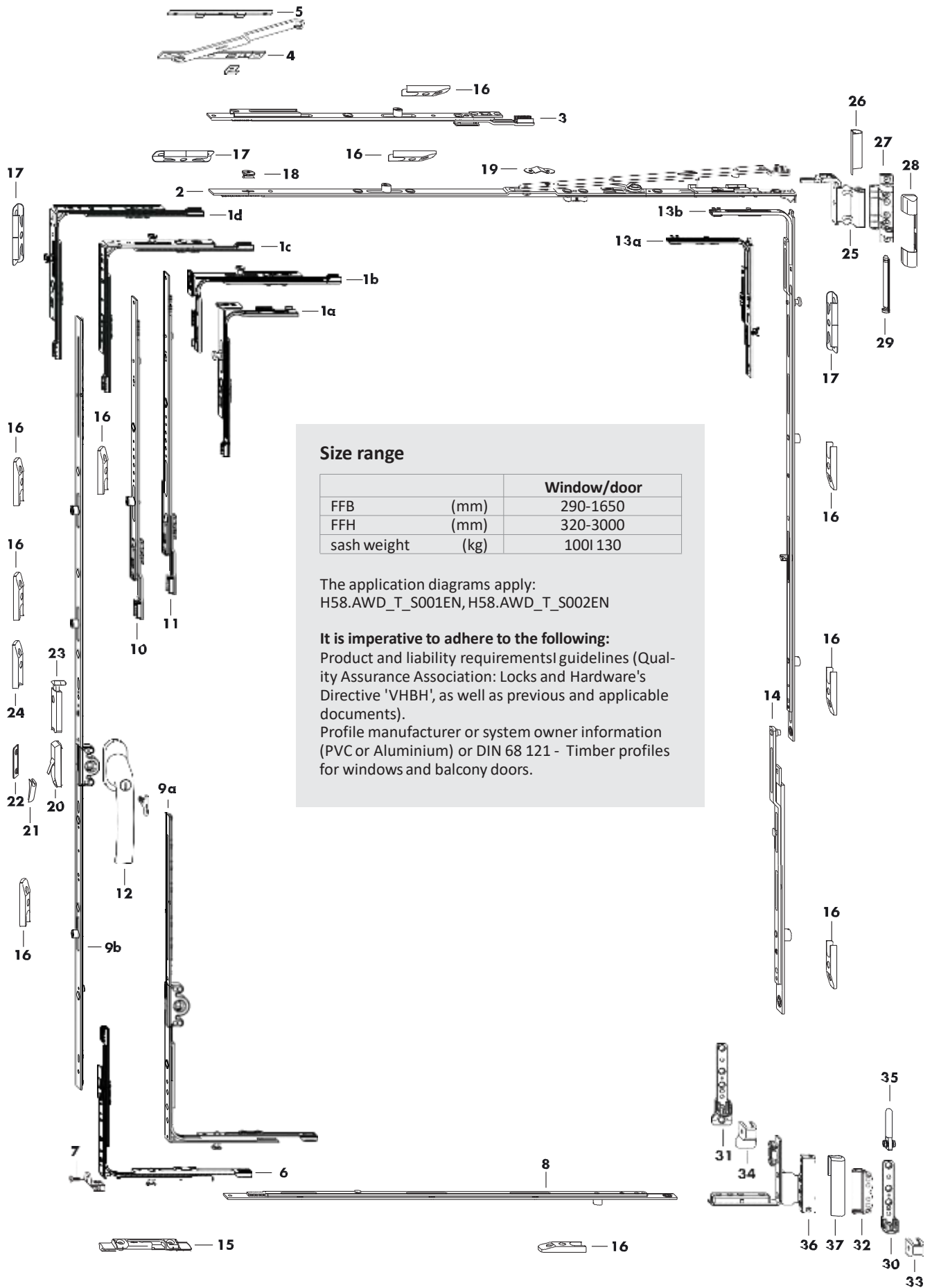

Size range

		Window/door
FFB	(mm)	290-1650
FFH	(mm)	320-3000
sash weight	(kg)	100 130

The application diagrams apply:
H58.AWD_T_S001EN, H58.AWD_T_S002EN

It is imperative to adhere to the following:
Product and liability requirements| guidelines (Quality Assurance Association: Locks and Hardware's Directive 'VHBH', as well as previous and applicable documents).
Profile manufacturer or system owner information (PVC or Aluminium) or DIN 68 121 - Timber profiles for windows and balcony doors.



List of fittings
1-sash square tilt before turn (TBT)
H12 GK Hinge side Si-line

FAVORIT

3P

Pos.	Description	Part number	QTY	FFB	FFH	Dimension G	Number of frame parts / Pos.		
							15	16	17
1a	corn.drive FAV VSO narrow 1S ..	FEUL0530- ...	1	290- 410	431-3000				1
1b	corn.drive FAV VSO narrow 1S ..	FEUL0530- ...	1	411- 800	320- 430				1
1c	corn.drive FAV VS 1S ..	FEUL0510- ...	1	411- 1260	431-3000				1
1d	corn.drive FAV VS 1S ..	FEUL0510- ...	1	1261- 1650	431-3000				1
2	stay 7 TBT sz 30	707357	1	290- 620					
	stay 7 TBT sz 35 MV	707364		621- 800					
	stay 7 TBT sz 50 MV	707371		801- 1030					
	stay 7 TBT sz 55 MV	707388		1031- 1260				1	
	stay 7 TBT sz 50 MV	707371		1261- 1490				1	
	stay 7 TBT sz 55 MV	707388		1491- 1650				1	
3	linkage SIZ TBT FAV 1V	FZOT0100- ...	1	1261- 1650				1	
4	additional stay	Ref. PDB, TSZS	1	1261- 1650					
5	packer Z	Ref. PDB, FRUP01	1	1261- 1650					
6	corn.drive FAV VS 1S ..	FEUL0510- ...	1	290- 1650	601-3000		1		
7	sash lift S-ES	Ref. PDB, FMFH	1	290- 1650					
8	centre lock sz 50	700969	1	1031- 1260				1	
	centre lock sz 70	700976		1261- 1490				1	
	centre lock sz 90	700983		1491- 1650				1	
9a	gear 15 FAV sz 30IG180 S-ES	FGKK4020- ...	1	411- 800	320- 430	180	1		
	gear 15 FAV sz 30IG180 S-ES	FGKK4020- ...		290- 1260	431- 600	180	1		
9b	gear 15 FAV sz 60IG300	FGKK4030- ...	1		601- 800	300			
	gear 15 FAV sz 80IG400 1V	FGKK4050- ...			801- 1000	400			
	gear 15 FAV sz 100IG500 1V	FGKK4060- ...			1001- 1200	500	1		
	gear 15 FAV sz 120IG600 1V	FGKK4070- ...			1201- 1400	600	1		
	gear 15 FAV sz 140IG700 2V	FGKK4200- ...			1401- 1600	700	1		
	gear 15 FAV sz 160IG700 2V 70	FGKK4090- ...			1601- 1800	700	1		
	gear 15 FAV sz 180IG1000 2V	FGKK4220- ...			1801- 2000	1000	2		
	gear 15 FAV sz 200IG1000 3V	FGKK4230- ...			2001- 3000	1000	3		
10	linkage FAV sz 200 A0767	FZSZ0120- ...	1		2201- 2400				
	linkage FAV sz 400 1V	FZSZ0110- ...			2401- 3000		1		
11	linkage FAV sz 200 A0767	FZSZ0120- ...	1		2601- 2800				
	linkage FAV sz 400 A0767	FZSZ0130- ...			2801- 3000				
12	handle Globe TBT lockable	Ref.access. ZHGT	1		320- 3000				
13a	corn.drive BS sz 20 1S ..	FEUL2100- ...	1		320- 1000				1
13b	corn.drive BS sz 50 1S 1V ..	FEUL2110- ...	1		1001- 1200			1	1
	corn.drive BS sz 70 1S 1V ..	FEUL2120- ...			1201- 1600			1	1
	corn.drive BS sz 90 1S 1V ..	FEUL2130- ...			1601- 2000			1	1
	corn.drive BS sz 130 1S 2V ..	FEUL2140- ...			2001- 3000			2	1
14	MV extension sz 60	700952	1		2401- 3000			1	
15	tilt lock bear. S-ES FH TBT	Ref. PDB, FRKB							
16	striker plate 56	Ref. PDB, FRSB							
17	striker plate S-RS	Ref. PDB, TRSK							
on request									
18	location piece ..	702543	1						
19	tilt restrictor ..	805701	1		320- 800				
20	mishandling device FAV.	FFBS0110- ...	1						
21	pressure piece	Ref. PDB, TFFD	1						
22	stop	Ref. PDB, FRZF01	1						
23	snapper switchable rh.	TFST0011- ...	1		1801- 3000				
	snapper switchable lh.	TFST0012- ...			1801- 3000				
24	frame part snapper	Ref. PDB, TRST	1		1801- 3000				



Pos.	Description	Hinge side turning points			required as per sash weight	
		surface TS	Part number		100 kg	130 kg
			RAL9016	RAL8022		
25	stay hinge	Ref. PDB, FBWB			1	1
26	cover cap W timber		FKWB0020-004 ...	FKWB0020-012 ...	1	1
27	top hinge S	Ref. PDB, FBSL02			1	1
28	cover cap S		FKSL0010-004 ...	FKSL0010-012 ...	1	1
29	top hinge pin diam.6	FBSB0010-1 ...			1	1
30	bottom hinge	Ref. PDB, FBEL01			1	
31	bottom hinge S	Ref. PDB, FBEL02				1
32	filling piece H timber	Ref. PDB, FBFS			1	1
33	cover cap EL U		FKEU0010-004 ...	FKEU0010-012 ...	1	
34	cover cap EL-S U		FKEL0010-004 ...	FKEL0010-012 ...		1
35	bottom hinge pin diam.6	TBLB0010-1 ...			1	1
36	reb.cor.hinge	Ref. PDB, TBFE81			1	1
37	cover cap FEB rh.		TKFE7011-004 ...	TKFE7011-012 ...	1	1
	cover cap FEB lh.		TKFE7012-004 ...	TKFE7012-012 ...	1	1



Frame dimensions

1-sash square tilt before turn (TBT)
H12 GK Hinge side Si-line

FAVORIT

3P

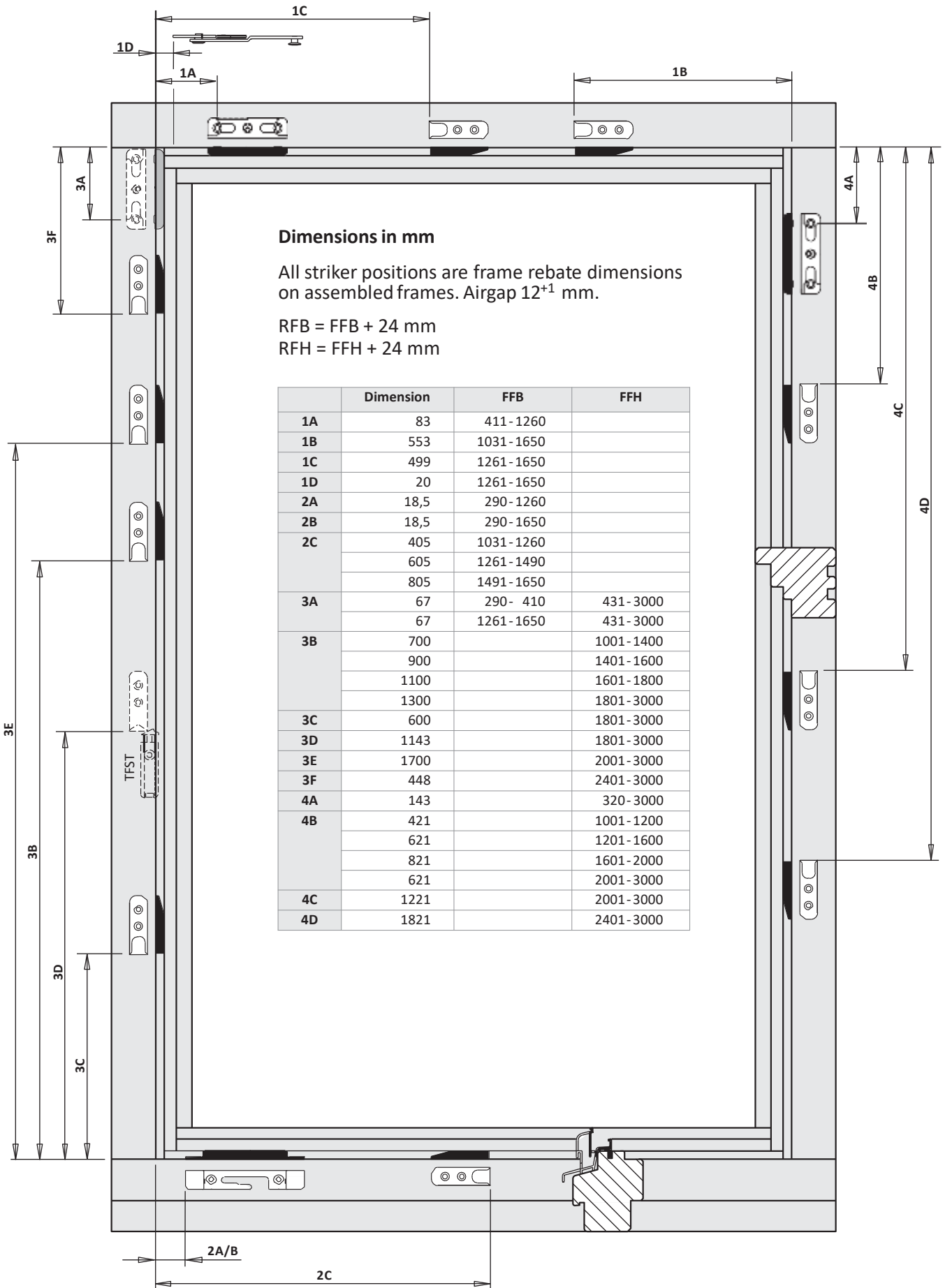

FAVORIT

Installation instructions



1-sash square turn

timber 12 mm

basic security

fixed handle position

Hinge side Si-line

surface TS

backset 15 mm

5

Hardware set configuration

Hardware set configuration	
General	Locking-points distance 1000
Stay side	one-piece stay
Bottom	loose sash lift
Locking side	mishandl. device on gear
Hinge side turning points	loose filling pc I pre-mounted

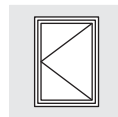

5

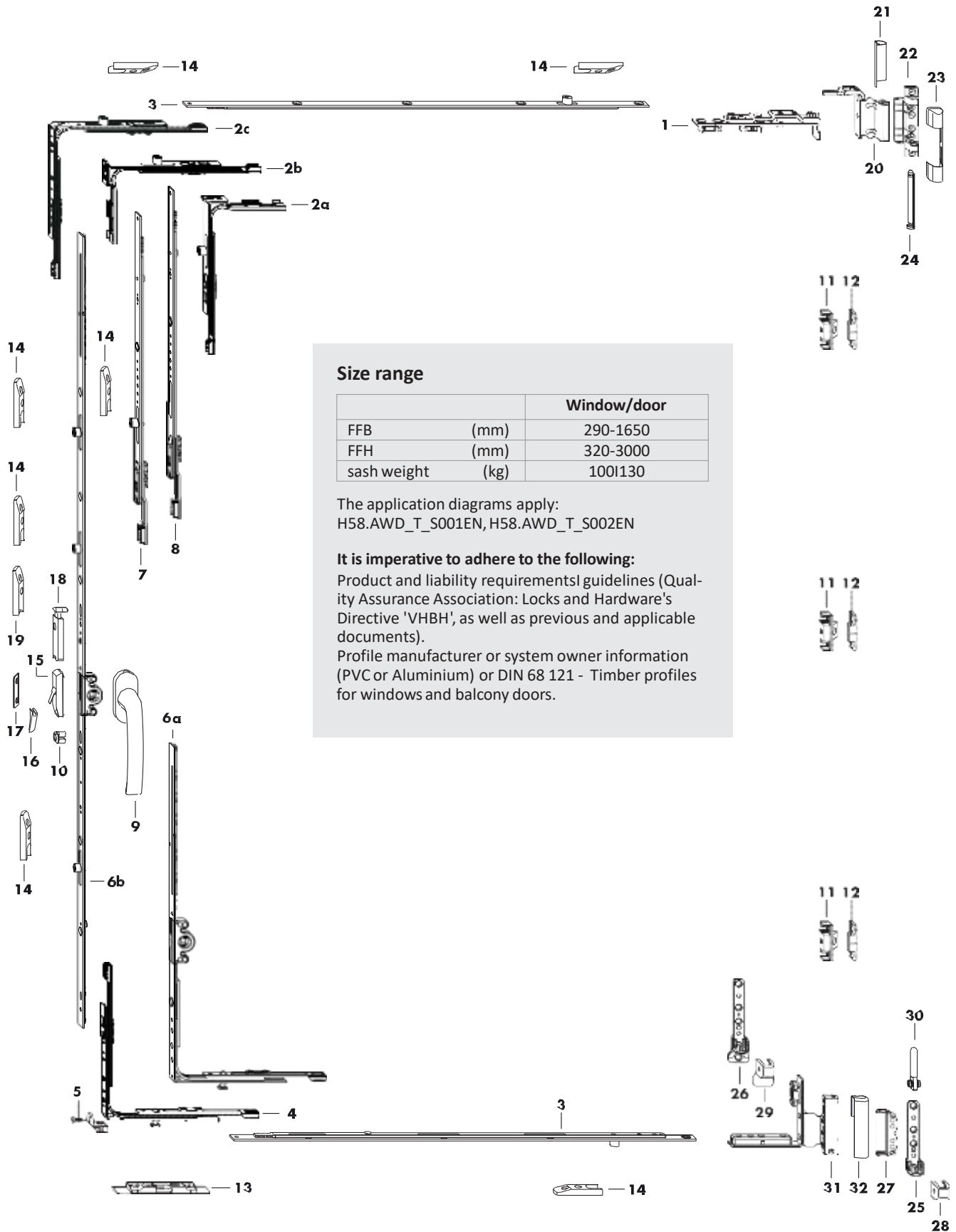

Size range

		Window/door
FFB	(mm)	290-1650
FFH	(mm)	320-3000
sash weight	(kg)	100 130

The application diagrams apply:
H58.AWD_T_S001EN, H58.AWD_T_S002EN

It is imperative to adhere to the following:

Product and liability requirements| guidelines (Quality Assurance Association: Locks and Hardware's Directive 'VHBH', as well as previous and applicable documents).

Profile manufacturer or system owner information (PVC or Aluminium) or DIN 68 121 - Timber profiles for windows and balcony doors.

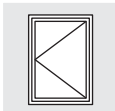

List of fittings
1-sash square turn
H12 GK Hinge side Si-line

FAVORIT

GS

Pos.	Description	Part number	QTY	FFB	FFH	Dimension G	Number of frame parts / Pos.	
							13	14
1	stay 7 DF	707340	1	290- 1650				
2a	corn.drive narrow VSO ..	FEUL0520- ...	1	290- 410	431- 3000			1
2b	corn.drive narrow VSO ..	FEUL0520- ...	1	411- 800	320- 430			1
2c	corn.drive VSO ..	FEUL0230- ...	1	411- 1650	431- 3000			1
3	centre lock sz 50	700969	2	1031- 1260				2
	centre lock sz 70	700976		1261- 1490				2
	centre lock sz 90	700983		1491- 1650				2
4	corn.drive FAV VS 1S ..	FEUL0510- ...	1	290- 1650	601- 3000		1	
5	sash lift S-ES	Ref. PDB, FMFH	1	290- 1650				
6a	gear 15 FAV sz 30IG180 S-ES	FGKK4020- ...	1	411- 800	320- 430	180	1	
	gear 15 FAV sz 30IG180 S-ES	FGKK4020- ...		290- 1260	431- 600	180	1	
6b	gear 15 FAV sz 60IG300	FGKK4030- ...	1		601- 800	300		
	gear 15 FAV sz 80IG400 1V	FGKK4050- ...			801- 1000	400		1
	gear 15 FAV sz 100IG500 1V	FGKK4060- ...			1001- 1200	500		1
	gear 15 FAV sz 120IG600 1V	FGKK4070- ...			1201- 1400	600		1
	gear 15 FAV sz 140IG700 2V	FGKK4200- ...			1401- 1600	700		1
	gear 15 FAV sz 160IG700 2V 70	FGKK4090- ...			1601- 1800	700		2
	gear 15 FAV sz 180IG1000 2V	FGKK4220- ...			1801- 2000	1000		2
	gear 15 FAV sz 200IG1000 3V	FGKK4230- ...			2001- 3000	1000		3
7	linkage FAV sz 200 A0767	FZSZ0120- ...	1		2201- 2400			
	linkage FAV sz 400 1V	FZSZ0110- ...			2401- 3000			1
8	linkage FAV sz 200 A0767	FZSZ0120- ...	1		2601- 2800			
	linkage FAV sz 400 A0767	FZSZ0130- ...			2801- 3000			
9	handle Globe	Ref.access. ZHGS	1		320- 3000			
10	travel restrictor	TFHB0010- ...	1		320- 3000			
11	sash part MV	Ref. PDB, ZFMV01	1		1001- 1600			
	sash part MV	Ref. PDB, ZFMV01	2		1601- 2400			
	sash part MV	Ref. PDB, ZFMV01	3		2401- 3000			
12	frame part MV	Ref. PDB, ZRZM01	1		1001- 1600			
	frame part MV	Ref. PDB, ZRZM01	2		1601- 2400			
	frame part MV	Ref. PDB, ZRZM01	3		2401- 3000			
13	tilt lock bear. S-ES FH	Ref. PDB, FRKA						
14	striker plate 56	Ref. PDB, FRSB						
on request								
15	mishandling device FAV.	FFBS0110- ...	1					
16	pressure piece	Ref. PDB, TFFD	1					
17	stop	Ref. PDB, FRZF01	1					
18	snapper switchable rh.	TFST0011- ...	1		1801- 3000			
	snapper switchable lh.	TFST0012- ...			1801- 3000			
19	frame part snapper	Ref. PDB, TRST	1		1801- 3000			

Pos.	Description	Hinge side turning points				required as per sash weight	
		Part number			100 kg	130 kg	
		surface TS	RAL9016	RAL8022			
20	stay hinge	Ref. PDB, FBWB			1	1	
21	cover cap W timber		FKWB0020-004 ...	FKWB0020-012 ...	1	1	
22	top hinge S	Ref. PDB, FBSL02			1	1	
23	cover cap S		FKSL0010-004 ...	FKSL0010-012 ...	1	1	
24	top hinge pin diam.6	FBSB0010-1 ...			1	1	
25	bottom hinge	Ref. PDB, FBEL01			1		
26	bottom hinge S	Ref. PDB, FBEL02				1	
27	filling piece H timber	Ref. PDB, FBFS			1	1	
28	cover cap EL U		FKEU0010-004 ...	FKEU0010-012 ...	1		
29	cover cap EL-S U		FKEL0010-004 ...	FKEL0010-012 ...		1	
30	bottom hinge pin diam.6	TBLB0010-1 ...			1	1	
31	reb.cor.hinge	Ref. PDB, TBFE81			1	1	
32	cover cap FEB rh.		TKFE7011-004 ...	TKFE7011-012 ...	1	1	
	cover cap FEB lh.		TKFE7012-004 ...	TKFE7012-012 ...	1	1	

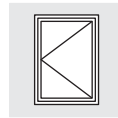

5

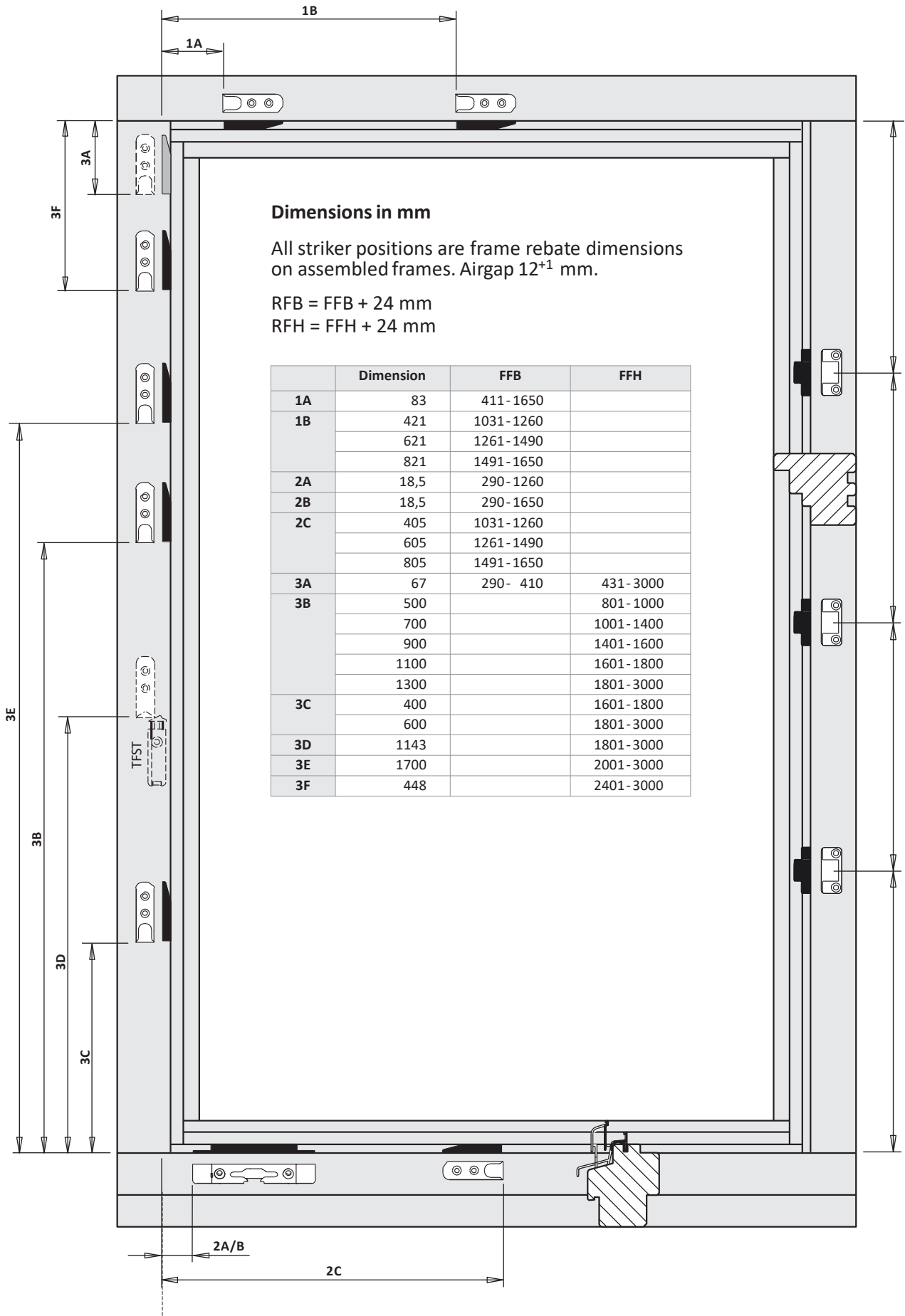

FAVORIT

Installation instructions



1-sash square turn
timber 12 mm
basic security
fixed handle position
Hinge side Si-line
surface TS
backset 15 mm

Hardware set configuration	
General	Locking-points distance 1000; gear DF
Stay side	one-piece stay
Locking side	mishandl. device on gear
Hinge side turning points	loose filling pc I pre-mounted

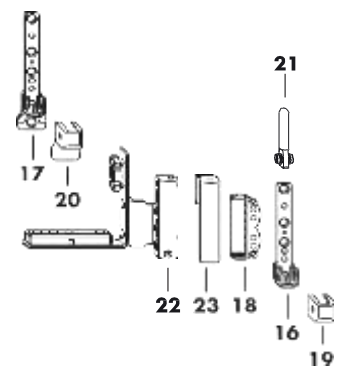
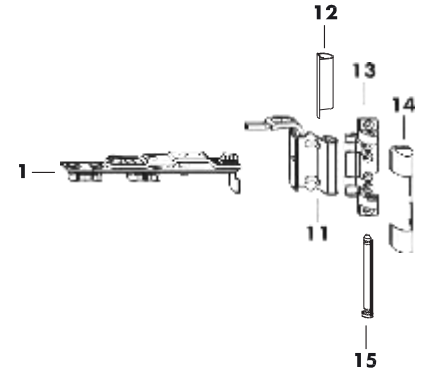
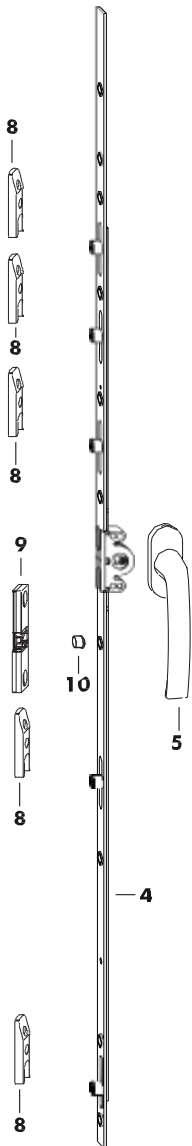
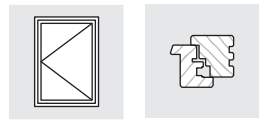

Size range

		Window/door
FFB	(mm)	290-800
FFH	(mm)	320-2400
sash weight	(kg)	100 130

The application diagrams apply:
H58.AWD_T_S001EN, H58.AWD_T_S002EN

It is imperative to adhere to the following:

Product and liability requirementsI guidelines (Quality Assurance Association: Locks and Hardware's Directive 'VHBH', as well as previous and applicable documents).

Profile manufacturer or system owner information (PVC or Aluminium) or DIN 68 121 - Timber profiles for windows and balcony doors.

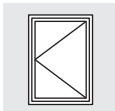

List of fittings
1-sash square turn
H12 GK Hinge side Si-line

FAVORIT

GS

Pos.	Description	Part number	QTY	FFB	FFH	Dimension G	Number of frame parts /
							Pos.
							8
1	stay 7 DF	707340	1	290- 800			
2	sash lift .. A2000	TFFH0010- ...	1	290- 800			
3	run-up FHITiP	Ref. PDB, TRAL	1	290- 800			
4	gear 15 FAVIDF sz 30IG180 1V	FGKD3510- ...	1		320- 430	180	1
	gear 15 FAVIDF sz 40IG180 2V	FGKD3520- ...			431- 600	180	2
	gear 15 FAVIDF sz 60IG300 2V	FGKD3530- ...			601- 800	300	2
	gear 15 FAVIDF sz 80IG400 2V	FGKD3540- ...			801-1000	400	2
	gear 15 FAVIDF sz 100IG500 3V	FGKD3550- ...			1001-1200	500	3
	gear 15 FAVIDF sz 120IG600 3V	FGKD3560- ...			1201-1400	600	3
	gear 15 FAVIDF sz 140IG700 4V	FGKD3570- ...			1401-1600	700	4
	gear 15 FAVIDF sz 160IG700 4V	FGKD3580- ...			1601-1800	700	4
	gear 15 FAVIDF sz 180IG1000 4V	FGKD3590- ...			1801-2000	1000	4
	gear 15 FAVIDF sz 200IG1000 4V	FGKD3600- ...			2001-2200	1000	4
gear 15 FAVIDF sz 220IG1000 5V	FGKD3610- ...		2201-2400	1000	5		
5	handle Globe	Ref.access. ZHGS	1		320-2400		
6	sash part MV	Ref. PDB, ZFMV01	1		1001-1600		
	sash part MV	Ref. PDB, ZFMV01	2		1601-2400		
7	frame part MV	Ref. PDB, ZRZM01	1		1001-1600		
	frame part MV	Ref. PDB, ZRZM01	2		1601-2400		
8	striker plate 56	Ref. PDB, FRSB					
on request							
9	snapper	Ref. PDB, FRZB	1		1801-2400		
10	sleeve	Ref. PDB, FFHU	1		1801-2400		

5

Hinge side turning points						
Pos.	Description	Part number			required as per sash weight	
		surface TS	RAL9016	RAL8022	100 kg	130 kg
11	stay hinge	Ref. PDB, FBWB			1	1
12	cover cap W timber		FKWB0020-004 ...	FKWB0020-012 ...	1	1
13	top hinge S	Ref. PDB, FBSL02			1	1
14	cover cap S		FKSL0010-004 ...	FKSL0010-012 ...	1	1
15	top hinge pin diam.6	FBSB0010-1 ...			1	1
16	bottom hinge	Ref. PDB, FBEL01			1	
17	bottom hinge S	Ref. PDB, FBEL02				1
18	filling piece H timber	Ref. PDB, FBFS			1	1
19	cover cap EL U		FKEU0010-004 ...	FKEU0010-012 ...	1	
20	cover cap EL-S U		FKEL0010-004 ...	FKEL0010-012 ...		1
21	bottom hinge pin diam.6	TBLB0010-1 ...			1	1
22	reb.cor.hinge	Ref. PDB, TBFE81			1	1
23	cover cap FEB rh.		TKFE7011-004 ...	TKFE7011-012 ...	1	1
	cover cap FEB lh.		TKFE7012-004 ...	TKFE7012-012 ...	1	1

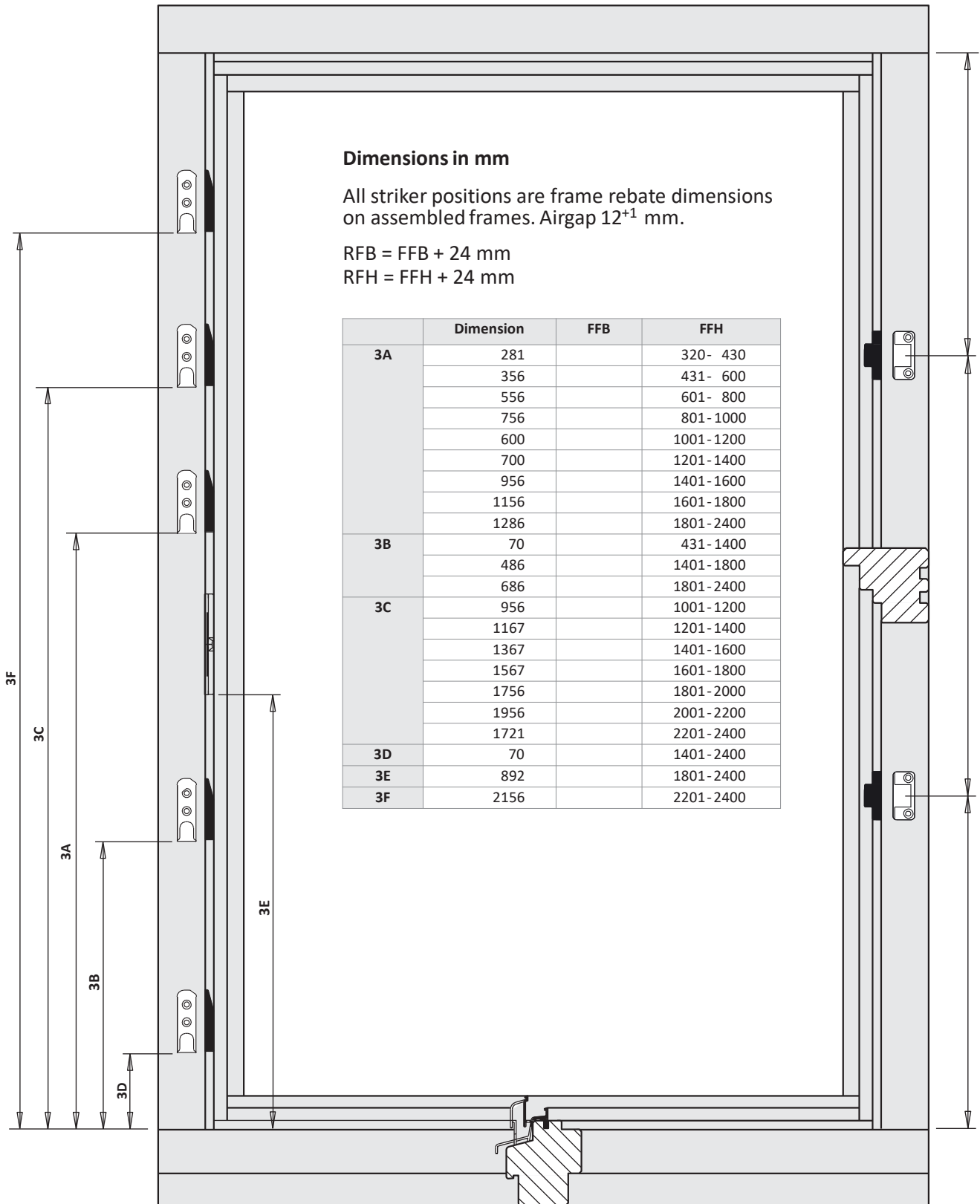
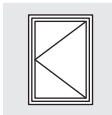

**Vertical tilt point**

1-sash square tilt-turn H48.FAVH2M0S500EN 6 - 3

2-sash square tilt-turn/turn shoot bolt H48.FAVH2M0S501EN 6 - 9

Horizontal tilt point - basic security

H48.FAVH2M0S600EN 6 - 17

1-sash square tilt-turn

2-sash square tilt-turn/turn DSG H48.FAVH2M0S601EN 6 - 23

2-sash square tilt-turn/turn shoot bolt H48.FAVH2M0S602EN 6 - 31

Tilt before turn (TBT) H48.FAVH2M0S604EN 6 - 39

1-sash square tilt before turn

Horizontal tilt point - 3-point security

H48.FAVH2M3PS600EN 6 - 45

1-sash square tilt-turn

2-sash square tilt-turn/turn DSG H48.FAVH2M3PS601EN 6 - 51

Tilt before turn (TBT) H48.FAVH2M3PS602EN 6 - 59

1-sash square tilt before turn

Turn only sash H48.FAVH2M0S605EN 6 - 65

1-sash square turn with gear DK

1-sash square turn with gear DF H48.FAVH2M0S606EN 6 - 69

Tilt sash

1-sash square tilt H48.FAVH2M0S607EN 6 - 73

FAVORIT

Installation instructions

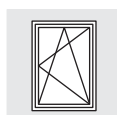

without
security

1-sash square tilt-turn

timber 12 mm

without security

centre handle pos. (variable)

Hinge side Si-line

surface TS

backset 15 mm

6

Hardware set configuration	
General	Locking-points distance 1000; vertical tilt point
Stay side	one-piece stay
Locking side	sash lift arm + mishandl.dev.
Hinge side	corner drive BS 2V
Hinge side turning points	loose filling pc I pre-mounted

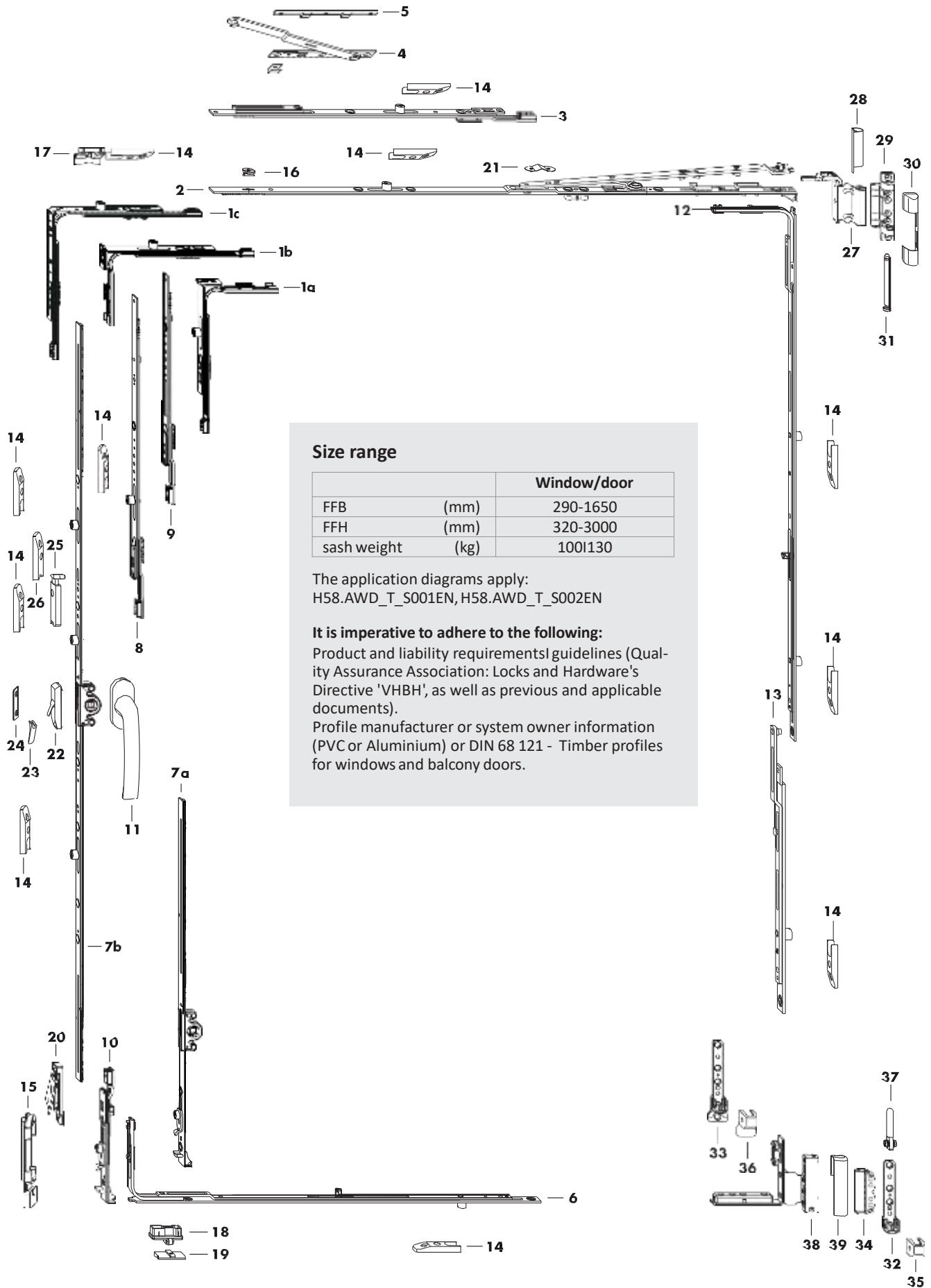
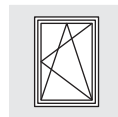

Size range

		Window/door
FFB	(mm)	290-1650
FFH	(mm)	320-3000
sash weight	(kg)	100 130

The application diagrams apply:
H58.AWD_T_S001EN, H58.AWD_T_S002EN

It is imperative to adhere to the following:
Product and liability requirements guidelines (Quality Assurance Association: Locks and Hardware's Directive 'VHBH', as well as previous and applicable documents).
Profile manufacturer or system owner information (PVC or Aluminium) or DIN 68 121 - Timber profiles for windows and balcony doors.



List of fittings
1-sash square tilt-turn
H12 GM Hinge side Si-line

FAVORIT
without security

Pos.	Description	Part number	QTY	FFB	FFH	Dimension G	Number of frame parts / Pos.	
							14	15
1a	corn.drive narrow VSO ..	FEUL0520- ...	1	290- 410	431-3000		1	
1b	corn.drive narrow VSO ..	FEUL0520- ...	1	411- 800	320- 430		1	
1c	corn.drive VSO ..	FEUL0230- ...	1	411- 1650	431- 3000		1	
2	stay 7 sz 30	707302	1	290- 620				
	stay 7 sz 35 MV	707319		621- 800				
	stay 7 sz 50 MV	707326		801- 1030				
	stay 7 sz 55 MV	707333		1031- 1260			1	
	stay 7 sz 50 MV	707326		1261- 1490			1	
	stay 7 sz 55 MV	707333		1491- 1650			1	
3	linkage SIZ FAV 1V	FZOK0100- ...	1	1261- 1650			1	
4	additional stay	Ref. PDB, TSZS	1	1261- 1650				
5	packer Z	Ref. PDB, FRUP01	1	1261- 1650				
6	corn.drive VSU BS sz 50 1V ..	FEUL2070- ...	1	1031- 1260			1	
	corn.drive VSU BS sz 70 1V ..	FEUL2080- ...		1261- 1490			1	
	corn.drive VSU BS sz 90 1V ..	FEUL2090- ...		1491- 1650			1	
7a	gear 15 FAV sz 30IG180	FGKK4010- ...	1	411- 800	320- 430	180		1
	gear 15 FAV sz 30IG180	FGKK4010- ...			431- 600	180		1
7b	gear 15 FAV sz 60	FGMK4020- ...	1		601- 800	300- 400		
	gear 15 FAV sz 80 1V	FGMK4040- ...			801- 1000	400- 500		
	gear 15 FAV sz 80 1V	FGMK4040- ...			1001- 1200	500- 600	1	
	gear 15 FAV sz 120 1V	FGMK4050- ...			1201- 1400	600- 700	1	
	gear 15 FAV sz 120 2V	FGMK4070- ...			1401- 1600	700- 800	2	
	gear 15 FAV sz 160 2V	FGMK4060- ...			1601- 2000	800- 1000	2	
	gear 15 FAV sz 200 3V	FGMK4110- ...			2001- 2400	1000- 1200	2	
	gear 15 FAV sz 200 3V	FGMK4110- ...			2401- 3000	1200	2	
8	linkage FAV sz 200 A0767	FZSZ0120- ...	1		2401- 2600			
	linkage FAV sz 400 1V	FZSZ0110- ...			2601- 3000		1	
9	linkage FAV sz 200 A0767	FZSZ0120- ...	1		2801- 3000			
10	tilt lock element FAVIFH	FEKB1010- ...	1		601- 3000			1
11	handle Globe	Ref.access. ZHGS	1		320- 3000			
12	corn.drive VSU BS sz 50 1V ..	FEUL2070- ...	1		1001- 1200		1	
	corn.drive VSU BS sz 70 1V ..	FEUL2080- ...			1201- 1600		1	
	corn.drive VSU BS sz 90 1V ..	FEUL2090- ...			1601- 2000		1	
	corn.drive BS sz 130 2V ..	FEUL2630- ...			2001- 3000		2	
13	MV extension sz 60	700952	1		2401- 3000		1	
14	striker plate 56	Ref. PDB, FRSB						
15	tilt striker plate FHA	Ref. PDB, TRKV						
on request								
16	location piece ..	702543	1					
17	frame part SP-S	Ref. PDB, FRZL01	1					
18	sash lift .. A2000	TFFH0010- ...	1		320- 600			
19	run-up FHITIP	Ref. PDB, TRAL	1		320- 600			
	sash lift KRB .. rh.	TFFH0151- ...			601- 3000			
	sash lift KRB .. lh.	TFFH0152- ...	1		601- 3000			
21	tilt restrictor ..	805701	1		320- 800			
22	mishandling device FAV.	FFBS0110- ...	1					
23	pressure piece	Ref. PDB, TFFD	1					
24	stop	Ref. PDB, FRZF01	1					
25	snapper switchable rh.	TFST0011- ...	1		1601- 3000			
	snapper switchable lh.	TFST0012- ...			1601- 3000			
26	frame part snapper	Ref. PDB, TRST	1		1601- 3000			

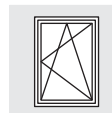

Pos.	Description	Hinge side turning points			required as per sash weight	
		surface TS	Part number		100 kg	130 kg
			RAL9016	RAL8022		
27	stay hinge	Ref. PDB, FBWB			1	1
28	cover cap W timber		FKWB0020-004 ...	FKWB0020-012 ...	1	1
29	top hinge S	Ref. PDB, FBSL02			1	1
30	cover cap S		FKSL0010-004 ...	FKSL0010-012 ...	1	1
31	top hinge pin diam.6	FBSB0010-1 ...			1	1
32	bottom hinge	Ref. PDB, FBEL01			1	
33	bottom hinge S	Ref. PDB, FBEL02				1
34	filling piece H timber	Ref. PDB, FBFS			1	1
35	cover cap EL U		FKEU0010-004 ...	FKEU0010-012 ...	1	
36	cover cap EL-S U		FKEL0010-004 ...	FKEL0010-012 ...		1
37	bottom hinge pin diam.6	TBLB0010-1 ...			1	1
38	reb.cor.hinge	Ref. PDB, TBFE81			1	1
39	cover cap FEB rh.		TKFE7011-004 ...	TKFE7011-012 ...	1	1
	cover cap FEB lh.		TKFE7012-004 ...	TKFE7012-012 ...	1	1

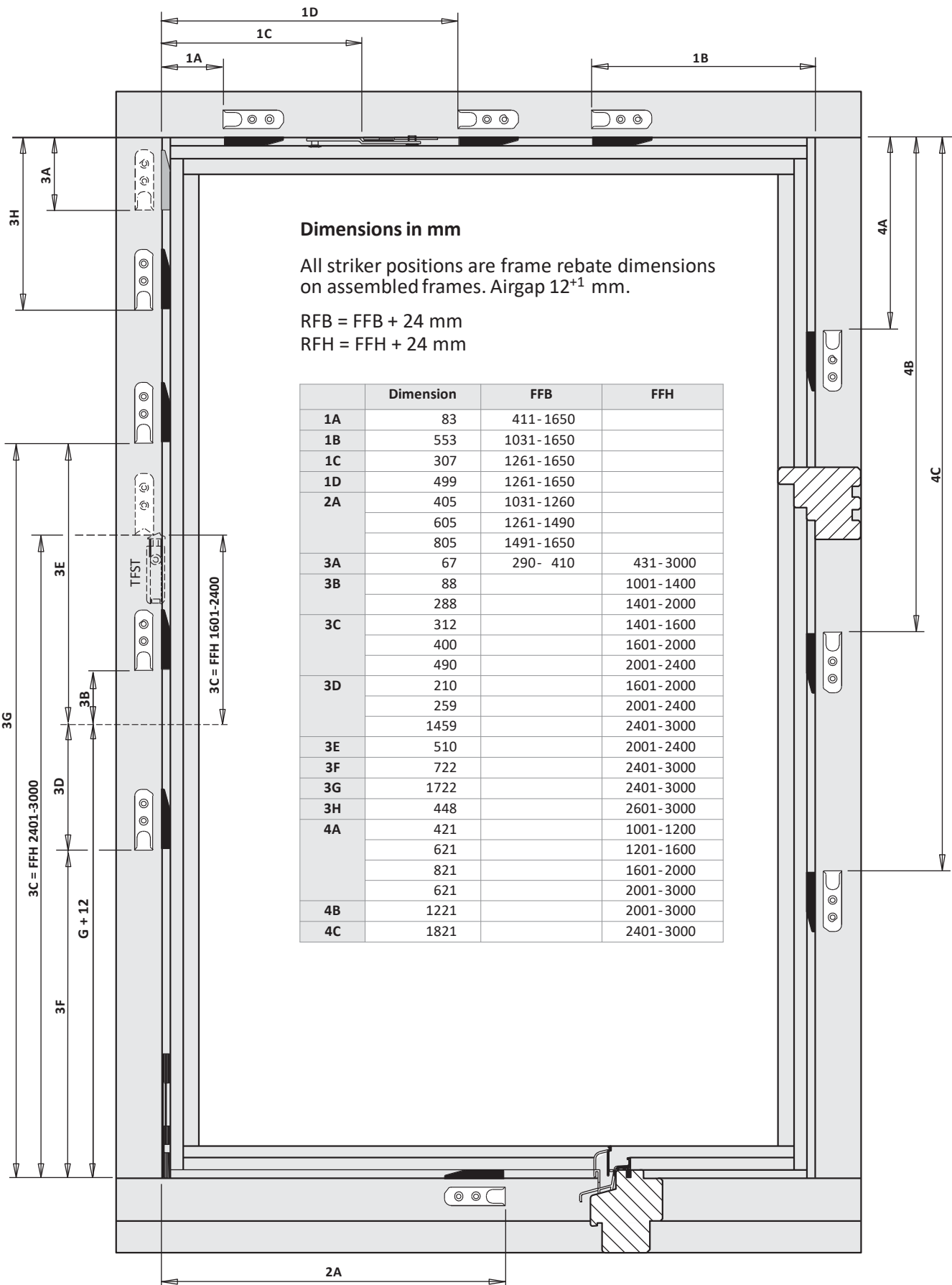

FAVORIT

Installation instructions

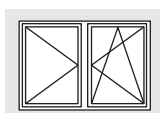

without
security

2-sash square tilt-turn turn shoot bolt

timber 12 mm

without security

centre handle pos. (variable)

Hinge side Si-line

surface TS

backset 15 mm

6

Hardware set configuration	
General	Locking-points distance 1000; vertical tilt point
Stay side	one-piece stay
Locking side	mishandl. device on gear
Hinge side	corner drive BS 2V
Hinge side turning points	loose filling pc I pre-mounted

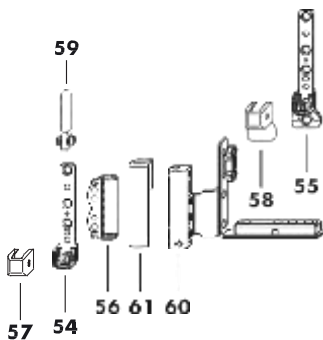
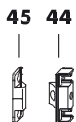
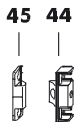
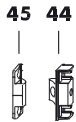
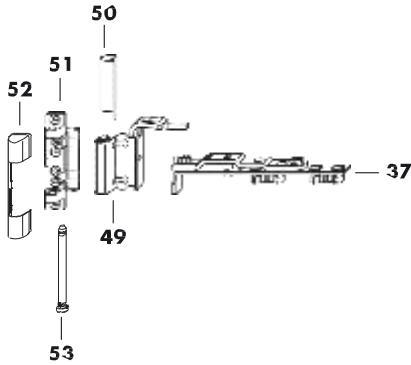
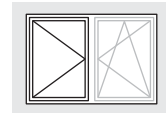

Size range

		Window/door
FFB	(mm)	290-800
FFH	(mm)	365-3000
sash weight	(kg)	100 130

The application diagrams apply:
H58.AWD_T_S001EN, H58.AWD_T_S002EN

It is imperative to adhere to the following:
Product and liability requirements/guidelines (Quality Assurance Association: Locks and Hardware's Directive 'VHBH', as well as previous and applicable documents).
Profile manufacturer or system owner information (PVC or Aluminium) or DIN 68 121 - Timber profiles for windows and balcony doors.

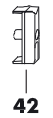
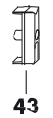

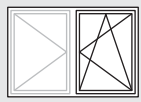

hardware layout main sash

2-sash square tilt-turn turn shoot bolt

H12 GM Hinge side Si-line

FAVORIT
without security

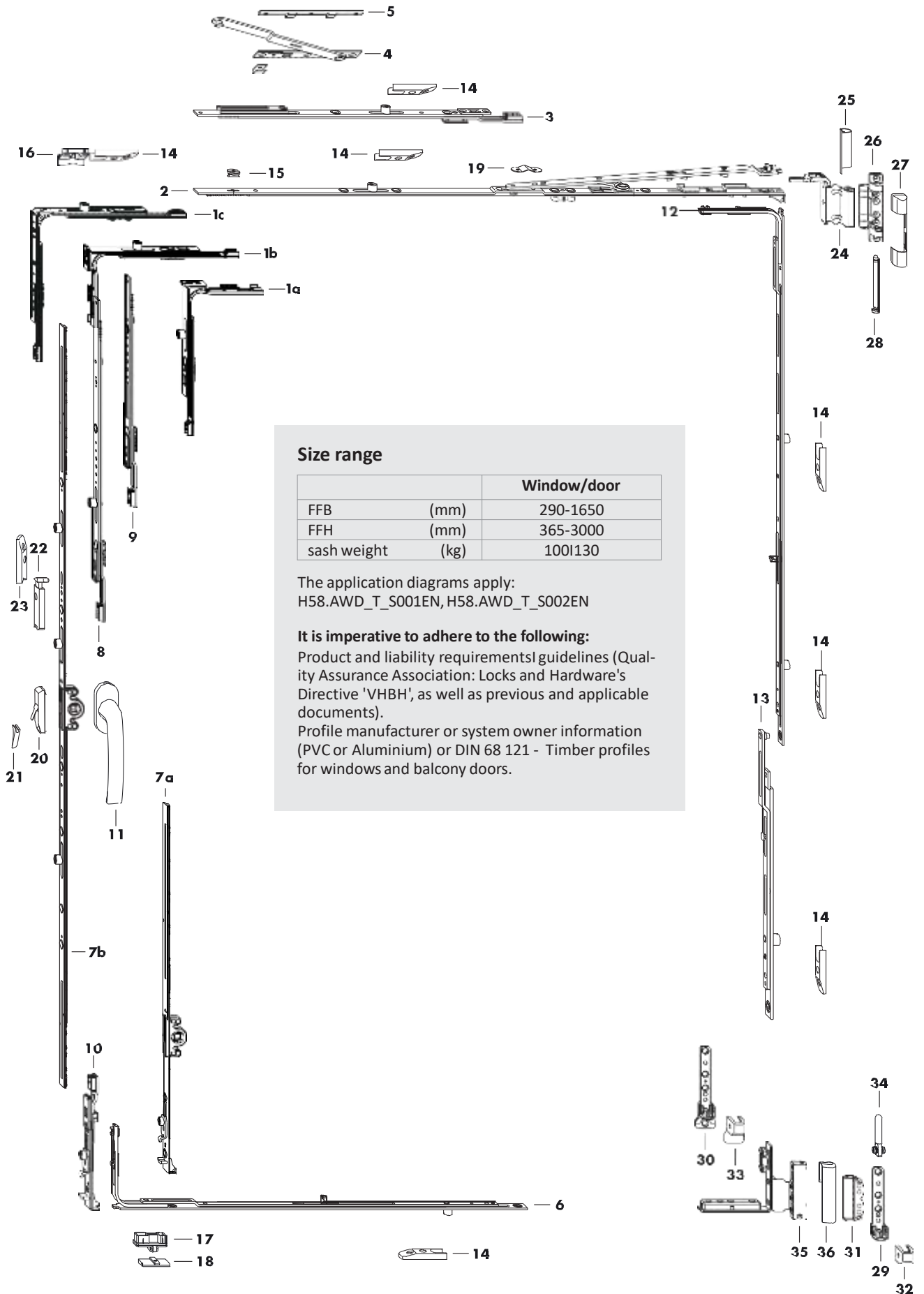

Size range

		Window/door
FFB	(mm)	290-1650
FFH	(mm)	365-3000
sash weight	(kg)	100 130

The application diagrams apply:
H58.AWD_T_S001EN, H58.AWD_T_S002EN

It is imperative to adhere to the following:

Product and liability requirements I guidelines (Quality Assurance Association: Locks and Hardware's Directive 'VHBH', as well as previous and applicable documents).

Profile manufacturer or system owner information (PVC or Aluminium) or DIN 68 121 - Timber profiles for windows and balcony doors.

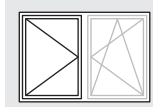

Pos.	Description	Part number	QTY	FFB	FFH	Dimension G	Number of frame parts / Pos.
						In the main sash	46
37	stay 7 DF	707340	1	290- 800			
38	sash lift .. A2000	TFFH0010- ...	1	290- 800			
39	run-up FHITiP	Ref. PDB, TRAL	1	290- 800			
40	shoot bolt VSO A2000	701195	1		365-3000		1
41	shoot bolt VSU A2000	701126	1		365-3000		1
42	striker plate 56 A2000	TRSB0030- ...	1		1001-1200	500- 600	
	striker plate 56 A2000	TRSB0030- ...			1201-1600	600- 800	
	striker plate 56 A2000	TRSB0030- ...			1601-2000	800-1000	
	striker plate 56 A2000	TRSB0030- ...		2	2001-2400	1000-1200	
	striker plate 56 A2000	TRSB0030- ...			2401-2600	1200	
43	striker plate 56 A2000	TRSB0030- ...	3		2601-3000	1200	
	sash part MV	Ref. PDB, ZFMV01	1		1001-1600		
	sash part MV	Ref. PDB, ZFMV01	2		1601-2400		
44	sash part MV	Ref. PDB, ZFMV01	3		2401-3000		
	frame part MV	Ref. PDB, ZRZM01	1		1001-1600		
	frame part MV	Ref. PDB, ZRZM01	2		1601-2400		
45	frame part MV	Ref. PDB, ZRZM01	3		2401-3000		
	striker V	Ref. PDB, FRZV01					
on request							
47	stop 2,2mm	710937	1		801-3000		
48	striker plate 56 A2000	TRSB0030- ...	1		1601-3000		

Hinge side turning points						
Pos.	Description	Part number			required as per sash weight	
		surface TS	RAL9016	RAL8022	100 kg	130 kg
49	stay hinge	Ref. PDB, FBWB			1	1
50	cover cap W timber		FKWB0020-004 ...	FKWB0020-012 ...	1	1
51	top hinge S	Ref. PDB, FBLS02			1	1
52	cover cap S		FKSL0010-004 ...	FKSL0010-012 ...	1	1
53	top hinge pin diam.6	FBSB0010-1 ...			1	1
54	bottom hinge	Ref. PDB, FBEL01			1	
55	bottom hinge S	Ref. PDB, FBEL02				1
56	filling piece H timber	Ref. PDB, FBFS			1	1
57	cover cap EL U		FKEU0010-004 ...	FKEU0010-012 ...	1	
58	cover cap EL-S U		FKEL0010-004 ...	FKEL0010-012 ...		1
59	bottom hinge pin diam.6	TBLB0010-1 ...			1	1
60	reb.cor.hinge	Ref. PDB, TBFE81			1	1
61	cover cap FEB rh.		TKFE7011-004 ...	TKFE7011-012 ...	1	1
	cover cap FEB lh.		TKFE7012-004 ...	TKFE7012-012 ...	1	1

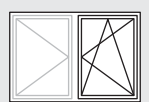

List of fittings main sash

2-sash square tilt-turn turn shoot bolt H12 GM Hinge side Si-line

FAVORIT
without security

Pos.	Description	Part number	QTY	FFB	FFH	Dimension G	Number of frame parts / Pos.
							14
1a	corn.drive narrow VSO ..	FEUL0520- ...	1	290- 410	431-3000		
1b	corn.drive narrow VSO ..	FEUL0520- ...	1	411- 800	365- 430		1
1c	corn.drive VSO ..	FEUL0230- ...	1	290- 1650			1
2	stay 7 sz 30	707302	1	290- 620			
	stay 7 sz 35 MV	707319		621- 800			
	stay 7 sz 50 MV	707326		801- 1030			
	stay 7 sz 55 MV	707333		1031- 1260			1
	stay 7 sz 50 MV	707326		1261- 1490			1
	stay 7 sz 55 MV	707333		1491- 1650			1
3	linkage SIZ FAV 1V	FZOK0100- ...	1	1261- 1650			1
4	additional stay	Ref. PDB, TSZS	1	1261- 1650			
5	packer Z	Ref. PDB, FRUP01	1	1261- 1650			
6	corn.drive VSU BS sz 50 1V ..	FEUL2070- ...	1	1031- 1260			1
	corn.drive VSU BS sz 70 1V ..	FEUL2080- ...		1261- 1490			1
	corn.drive VSU BS sz 90 1V ..	FEUL2090- ...		1491- 1650			1
7a	gear 15 FAV sz 30IG180	FGKK4010- ...	1	411- 800	365- 430		
	gear 15 FAV sz 30IG180	FGKK4010- ...			431- 600	180	
7b	gear 15 FAV sz 60	FGMK4020- ...	1		601- 800	300- 400	
	gear 15 FAV sz 80 1V	FGMK4040- ...			801- 1000	400- 500	
	gear 15 FAV sz 80 1V	FGMK4040- ...			1001- 1200	500- 600	
	gear 15 FAV sz 120 1V	FGMK4050- ...			1201- 1400	600- 700	
	gear 15 FAV sz 120 2V	FGMK4070- ...			1401- 1600	700- 800	
	gear 15 FAV sz 160 2V	FGMK4060- ...			1601- 2000	800- 1000	
	gear 15 FAV sz 200 3V	FGMK4110- ...			2001- 2400	1000- 1200	
	gear 15 FAV sz 200 3V	FGMK4110- ...			2401- 3000	1200	
8	linkage FAV sz 200 A0767	FZSZ0120- ...	1		2401- 2600		
	linkage FAV sz 400 1V	FZSZ0110- ...			2601- 3000		
9	linkage FAV sz 200 A0767	FZSZ0120- ...	1		2801- 3000		
10	tilt lock element FAVIFH	FEKB1010- ...	1		601- 3000		
11	handle Globe	Ref.access. ZHGS	1		365- 3000		
12	corn.drive VSU BS sz 50 1V ..	FEUL2070- ...	1		1001- 1200		1
	corn.drive VSU BS sz 70 1V ..	FEUL2080- ...			1201- 1600		1
	corn.drive VSU BS sz 90 1V ..	FEUL2090- ...			1601- 2000		1
	corn.drive BS sz 130 2V ..	FEUL2630- ...			2001- 3000		2
13	MV extension sz 60	700952	1		2401- 3000		1
14	striker plate 56	Ref. PDB, FRSB					
on request							
15	location piece ..	702543	1				
16	frame part SP-S	Ref. PDB, FRZL01	1				
17	sash lift .. A2000	TFFH0010- ...	1		365- 600		
18	run-up FHITiP	Ref. PDB, TRAL	1		365- 600		
19	tilt restrictor ..	805701	1		365- 800		
20	mishandling device FAV.	FFBS0110- ...	1				
21	pressure piece	Ref. PDB, TFFD	1				
22	snapper switchable rh.	TFST0011- ...	1		1601- 3000		
	snapper switchable lh.	TFST0012- ...			1601- 3000		
23	frame part snapper	Ref. PDB, TRST	1		1601- 3000		

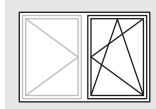

Pos.	Description	Hinge side turning points			required as per sash weight	
		surface TS	Part number		100 kg	130 kg
			RAL9016	RAL8022		
24	stay hinge	Ref. PDB, FBWB			1	1
25	cover cap W timber		FKWB0020-004 ...	FKWB0020-012 ...	1	1
26	top hinge S	Ref. PDB, FBSL02			1	1
27	cover cap S		FKSL0010-004 ...	FKSL0010-012 ...	1	1
28	top hinge pin diam.6	FBSB0010-1 ...			1	1
29	bottom hinge	Ref. PDB, FBEL01			1	
30	bottom hinge S	Ref. PDB, FBEL02				1
31	filling piece H timber	Ref. PDB, FBFS			1	1
32	cover cap EL U		FKEU0010-004 ...	FKEU0010-012 ...	1	
33	cover cap EL-S U		FKEL0010-004 ...	FKEL0010-012 ...		1
34	bottom hinge pin diam.6	TBLB0010-1 ...			1	1
35	reb.cor.hinge	Ref. PDB, TBFE81			1	1
36	cover cap FEB rh.		TKFE7011-004 ...	TKFE7011-012 ...	1	1
	cover cap FEB lh.		TKFE7012-004 ...	TKFE7012-012 ...	1	1

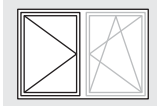

Frame dimensions slave sash
2-sash square tilt-turn turn shoot bolt
H12 GM Hinge side Si-line

FAVORIT
without security

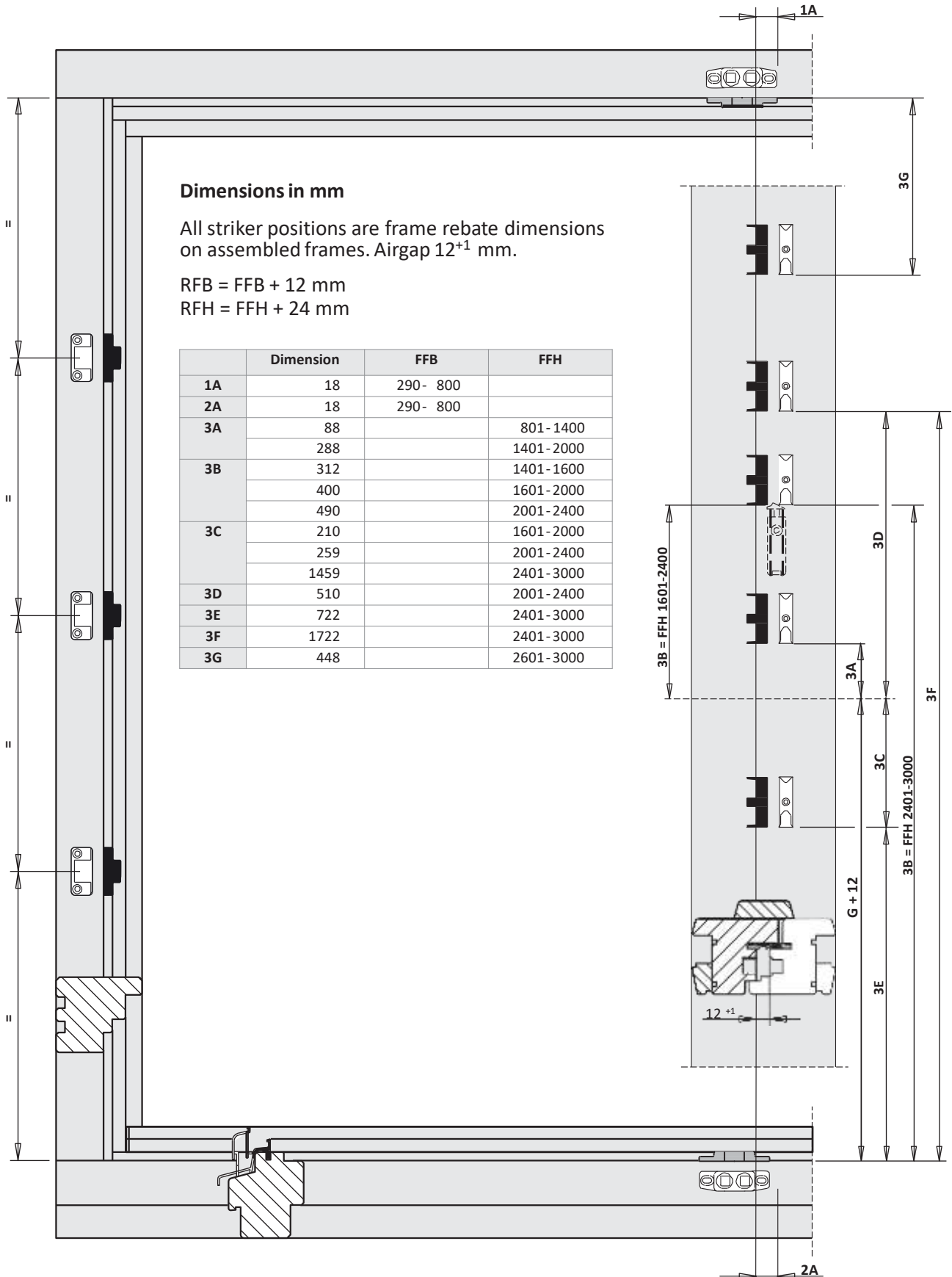

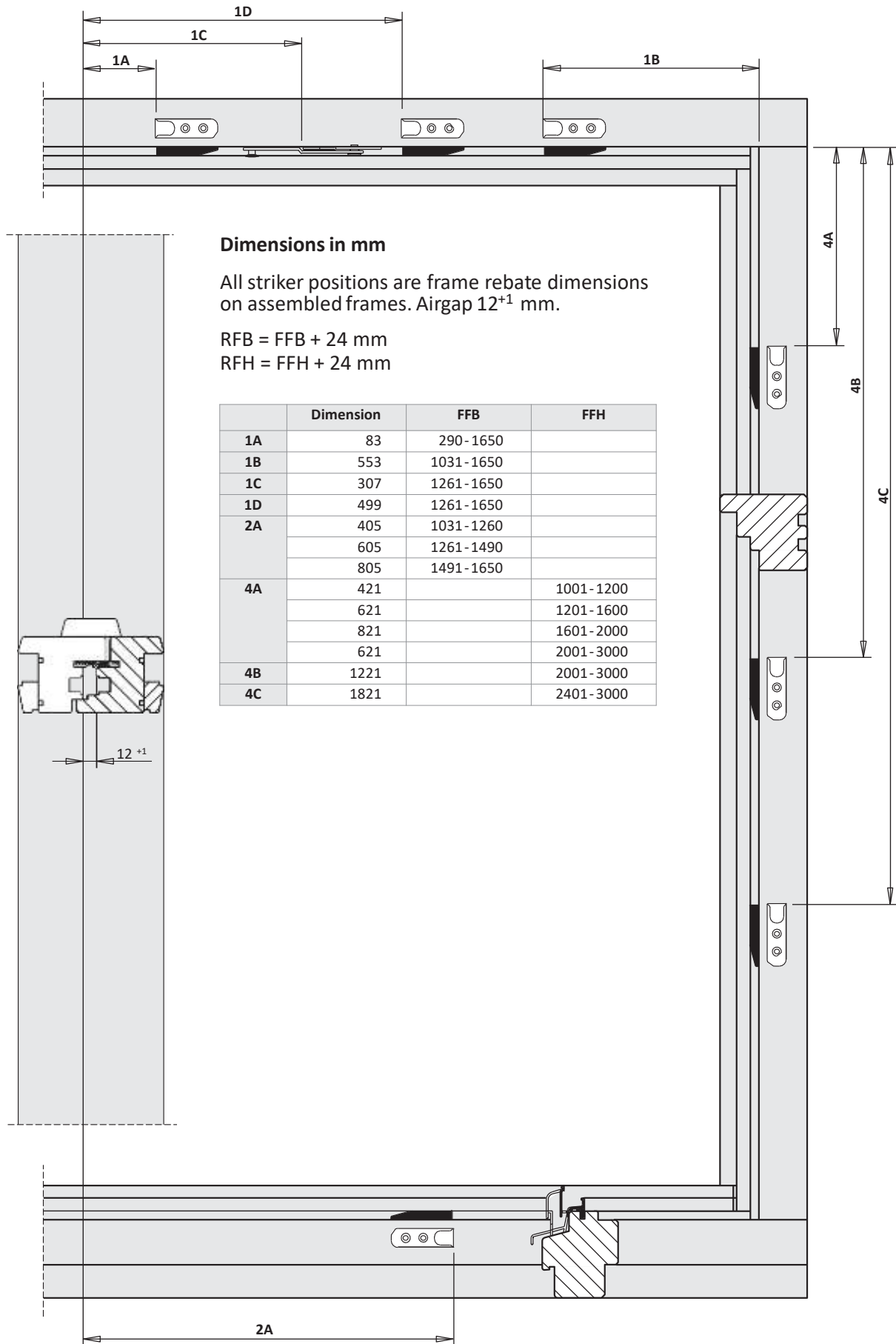
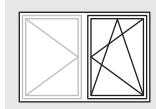

FAVORIT

Installation instructions



1-sash square tilt-turn

timber 12 mm

basic security

centre handle pos. (variable)

Hinge side Si-line

surface TS

backset 15 mm

6

Hardware set configuration	
General	Locking-points distance 1000
Stay side	one-piece stay
Bottom	loose sash lift
Locking side	mishandl. device on gear
Hinge side	corner drive BS 2V
Hinge side turning points	loose filling pc I pre-mounted

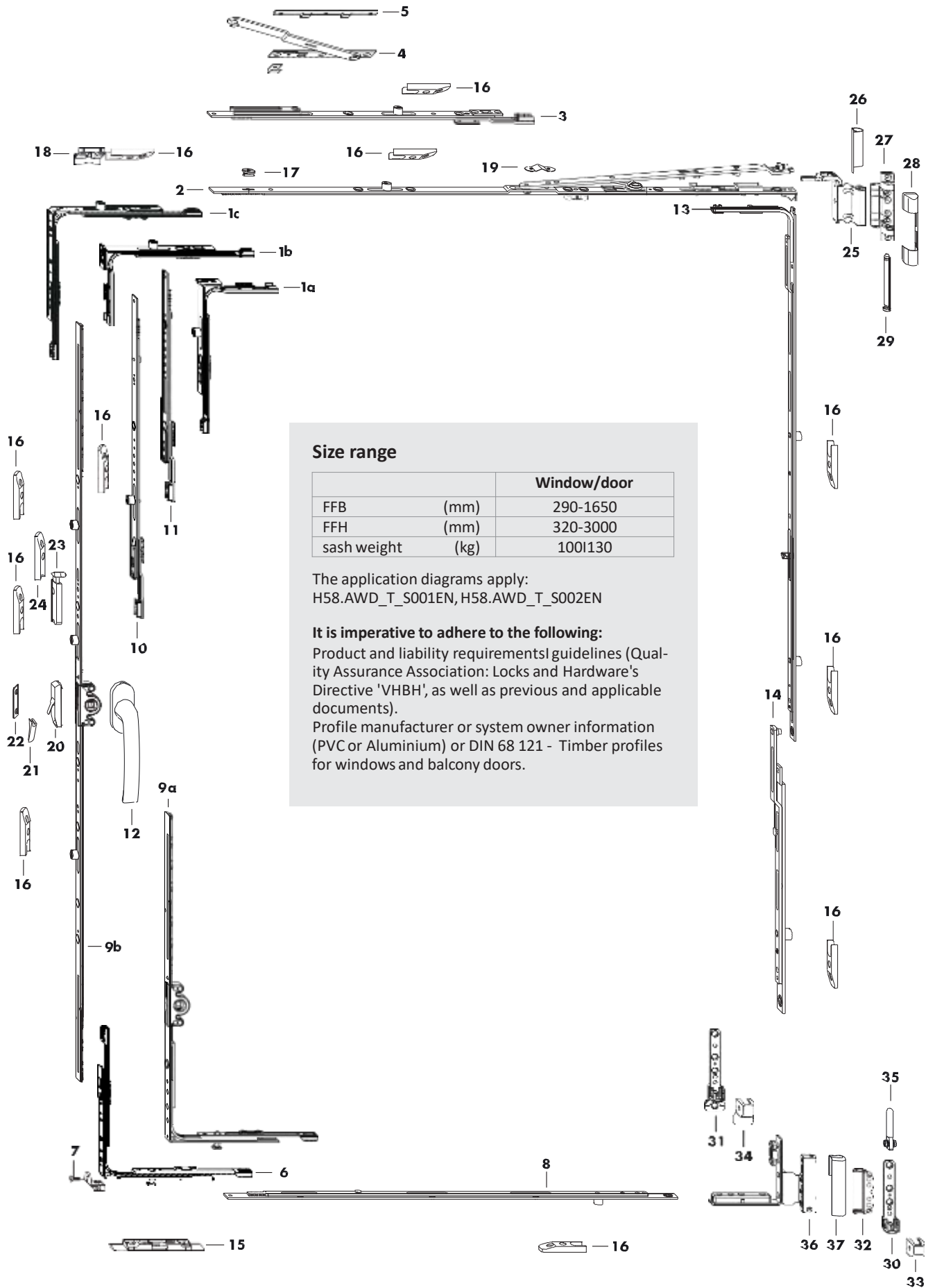
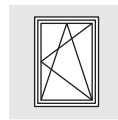

Size range

		Window/door
FFB	(mm)	290-1650
FFH	(mm)	320-3000
sash weight	(kg)	100 130

The application diagrams apply:
H58.AWD_T_S001EN, H58.AWD_T_S002EN

It is imperative to adhere to the following:
Product and liability requirements | guidelines (Quality Assurance Association: Locks and Hardware's Directive 'VHBH', as well as previous and applicable documents).
Profile manufacturer or system owner information (PVC or Aluminium) or DIN 68 121 - Timber profiles for windows and balcony doors.



List of fittings
1-sash square tilt-turn
H12 GM Hinge side Si-line

FAVORIT

GS

Pos.	Description	Part number	QTY	FFB	FFH	Dimension G	Number of frame parts / Pos.	
							15	16
1a	corn.drive narrow VSO ..	FEUL0520- ...	1	290- 410	431-3000			1
1b	corn.drive narrow VSO ..	FEUL0520- ...	1	411- 800	320- 430			1
1c	corn.drive VSO ..	FEUL0230- ...	1	411- 1650	431- 3000			1
2	stay 7 sz 30	707302	1	290- 620				
	stay 7 sz 35 MV	707319		621- 800				
	stay 7 sz 50 MV	707326		801- 1030				
	stay 7 sz 55 MV	707333		1031- 1260				1
	stay 7 sz 50 MV	707326		1261- 1490				1
	stay 7 sz 55 MV	707333		1491- 1650				1
3	linkage SIZ FAV 1V	FZOK0100- ...	1	1261- 1650				1
4	additional stay	Ref. PDB, TSZS	1	1261- 1650				
5	packer Z	Ref. PDB, FRUP01	1	1261- 1650				
6	corn.drive FAV VS 1S ..	FEUL0510- ...	1	290- 1650	601- 3000		1	
7	sash lift S-ES	Ref. PDB, FMFH	1	290- 1650				
8	centre lock sz 50	700969	1	1031- 1260				1
	centre lock sz 70	700976		1261- 1490				1
	centre lock sz 90	700983		1491- 1650				1
9a	gear 15 FAV sz 30IG180 S-ES	FGKK4020- ...	1	411- 800	320- 430	180	1	
	gear 15 FAV sz 30IG180 S-ES	FGKK4020- ...			431- 600	180	1	
9b	gear 15 FAV sz 60	FGMK4020- ...	1		601- 800	300- 400		
	gear 15 FAV sz 80 1V	FGMK4040- ...			801- 1000	400- 500		
	gear 15 FAV sz 80 1V	FGMK4040- ...			1001- 1200	500- 600		1
	gear 15 FAV sz 120 1V	FGMK4050- ...			1201- 1400	600- 700		1
	gear 15 FAV sz 120 2V	FGMK4070- ...			1401- 1600	700- 800		2
	gear 15 FAV sz 160 2V	FGMK4060- ...			1601- 2000	800- 1000		2
	gear 15 FAV sz 200 3V	FGMK4110- ...			2001- 2400	1000- 1200		2
	gear 15 FAV sz 200 3V	FGMK4110- ...			2401- 3000	1200		2
10	linkage FAV sz 200 A0767	FZSZ0120- ...	1		2401- 2600			
	linkage FAV sz 400 1V	FZSZ0110- ...			2601- 3000			1
11	linkage FAV sz 200 A0767	FZSZ0120- ...	1		2801- 3000			
12	handle Globe	Ref.access. ZHGS	1		320- 3000			
13	corn.drive VSU BS sz 50 1V ..	FEUL2070- ...	1		1001- 1200			1
	corn.drive VSU BS sz 70 1V ..	FEUL2080- ...			1201- 1600			1
	corn.drive VSU BS sz 90 1V ..	FEUL2090- ...			1601- 2000			1
	corn.drive BS sz 130 2V ..	FEUL2630- ...			2001- 3000			2
14	MV extension sz 60	700952	1		2401- 3000			1
15	tilt lock bear. S-ES FH	Ref. PDB, FRKA						
16	striker plate 56	Ref. PDB, FRSB						
on request								
17	location piece ..	702543	1					
18	frame part SP-S	Ref. PDB, FRZL01	1					
19	tilt restrictor ..	805701	1		320- 800			
20	mishandling device FAV.	FFBS0110- ...	1					
21	pressure piece	Ref. PDB, TFFD	1					
22	stop	Ref. PDB, FRZF01	1					
23	snapper switchable rh.	TFST0011- ...	1		1601- 3000			
	snapper switchable lh.	TFST0012- ...			1601- 3000			
24	frame part snapper	Ref. PDB, TRST	1		1601- 3000			

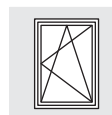

Pos.	Description	Hinge side turning points			required as per sash weight	
		surface TS	Part number		100 kg	130 kg
			RAL9016	RAL8022		
25	stay hinge	Ref. PDB, FBWB			1	1
26	cover cap W timber		FKWB0020-004 ...	FKWB0020-012 ...	1	1
27	top hinge S	Ref. PDB, FBSL02			1	1
28	cover cap S		FKSL0010-004 ...	FKSL0010-012 ...	1	1
29	top hinge pin diam.6	FBSB0010-1 ...			1	1
30	bottom hinge	Ref. PDB, FBEL01			1	
31	bottom hinge S	Ref. PDB, FBEL02				1
32	filling piece H timber	Ref. PDB, FBFS			1	1
33	cover cap EL U		FKEU0010-004 ...	FKEU0010-012 ...	1	
34	cover cap EL-S U		FKEL0010-004 ...	FKEL0010-012 ...		1
35	bottom hinge pin diam.6	TBLB0010-1 ...			1	1
36	reb.cor.hinge	Ref. PDB, TBFE81			1	1
37	cover cap FEB rh.		TKFE7011-004 ...	TKFE7011-012 ...	1	1
	cover cap FEB lh.		TKFE7012-004 ...	TKFE7012-012 ...	1	1

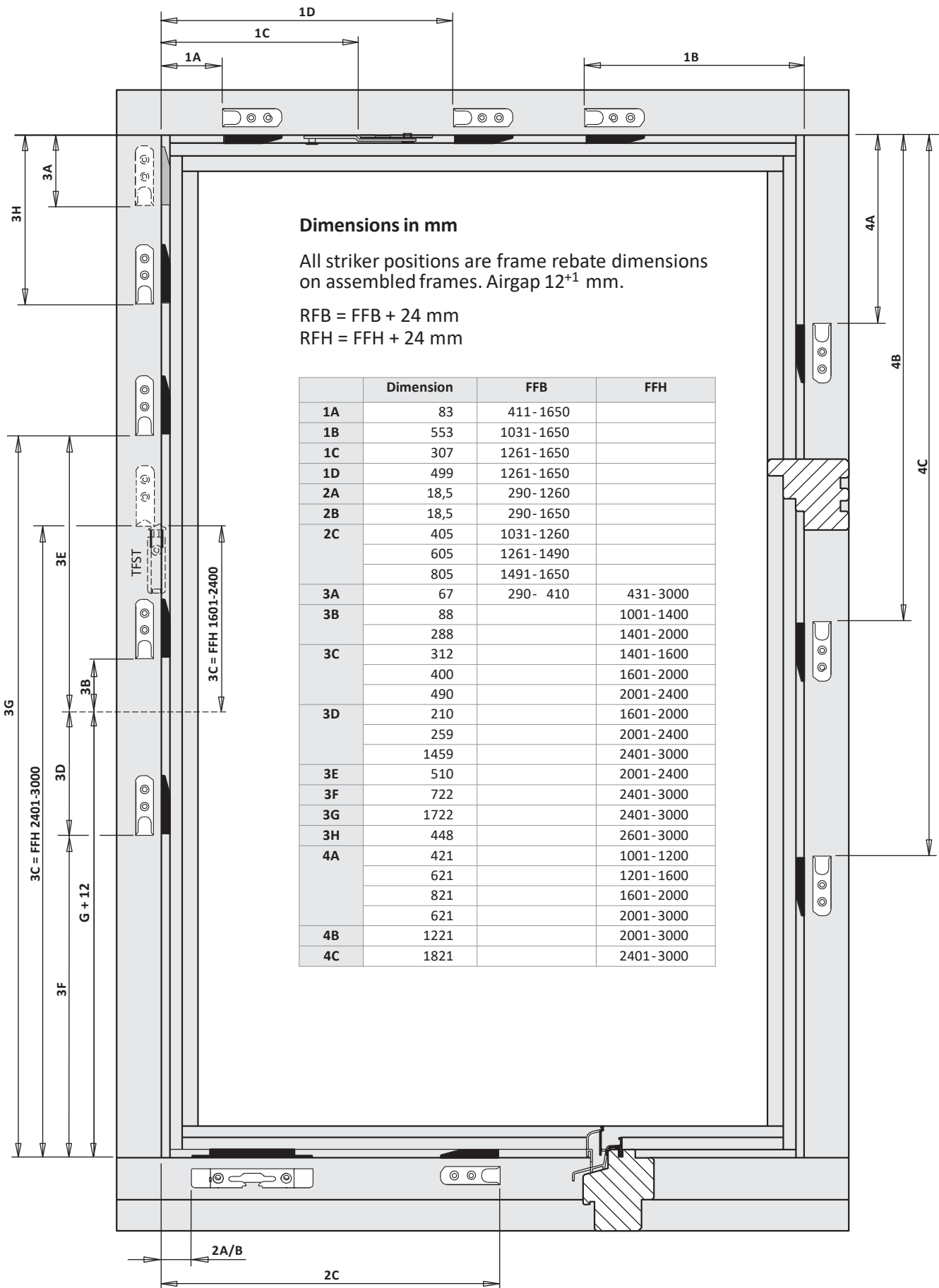

FAVORIT

Installation instructions

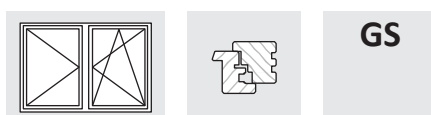

2-sash square tilt-turn/turn DSG gear

timber 12 mm

basic security

centre handle pos. (variable)

Hinge side Si-line

surface TS

backset 15 mm

6

Hardware set configuration	
General	Locking-points distance 1000
Stay side	one-piece stay
Bottom	loose sash lift
Locking side	mishandl. device on gear
Hinge side	corner drive BS 2V
Hinge side turning points	loose filling pc I pre-mounted

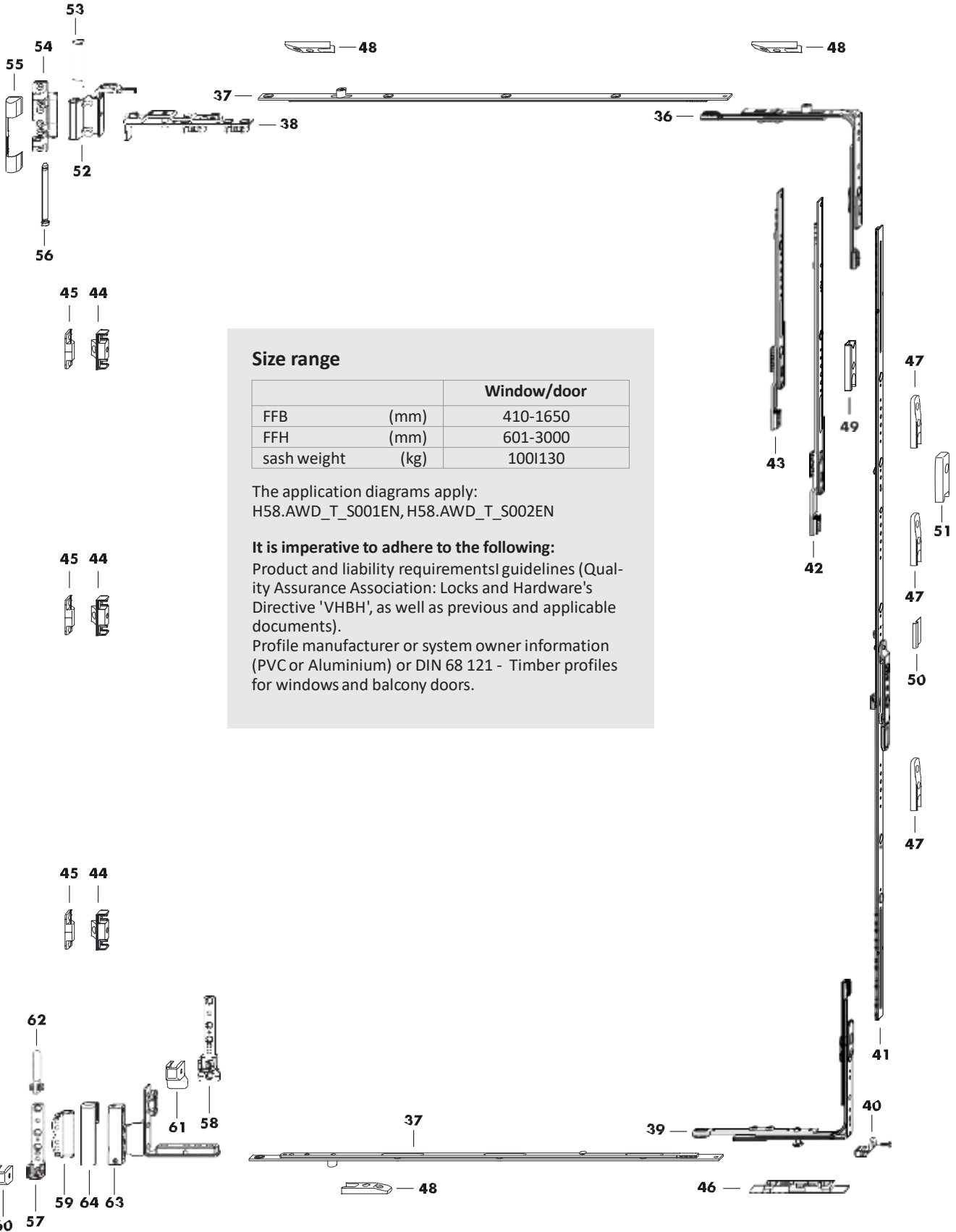
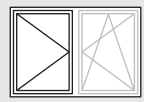

Size range

		Window/door
FFB	(mm)	410-1650
FFH	(mm)	601-3000
sash weight	(kg)	100 130

The application diagrams apply:
H58.AWD_T_S001EN, H58.AWD_T_S002EN

It is imperative to adhere to the following:

Product and liability requirements| guidelines (Quality Assurance Association: Locks and Hardware's Directive 'VHBH', as well as previous and applicable documents).

Profile manufacturer or system owner information (PVC or Aluminium) or DIN 68 121 - Timber profiles for windows and balcony doors.

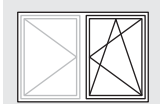

hardware layout main sash

2-sash square tilt-turn DSG gear
H12 GM Hinge side Si-line

FAVORIT

GS

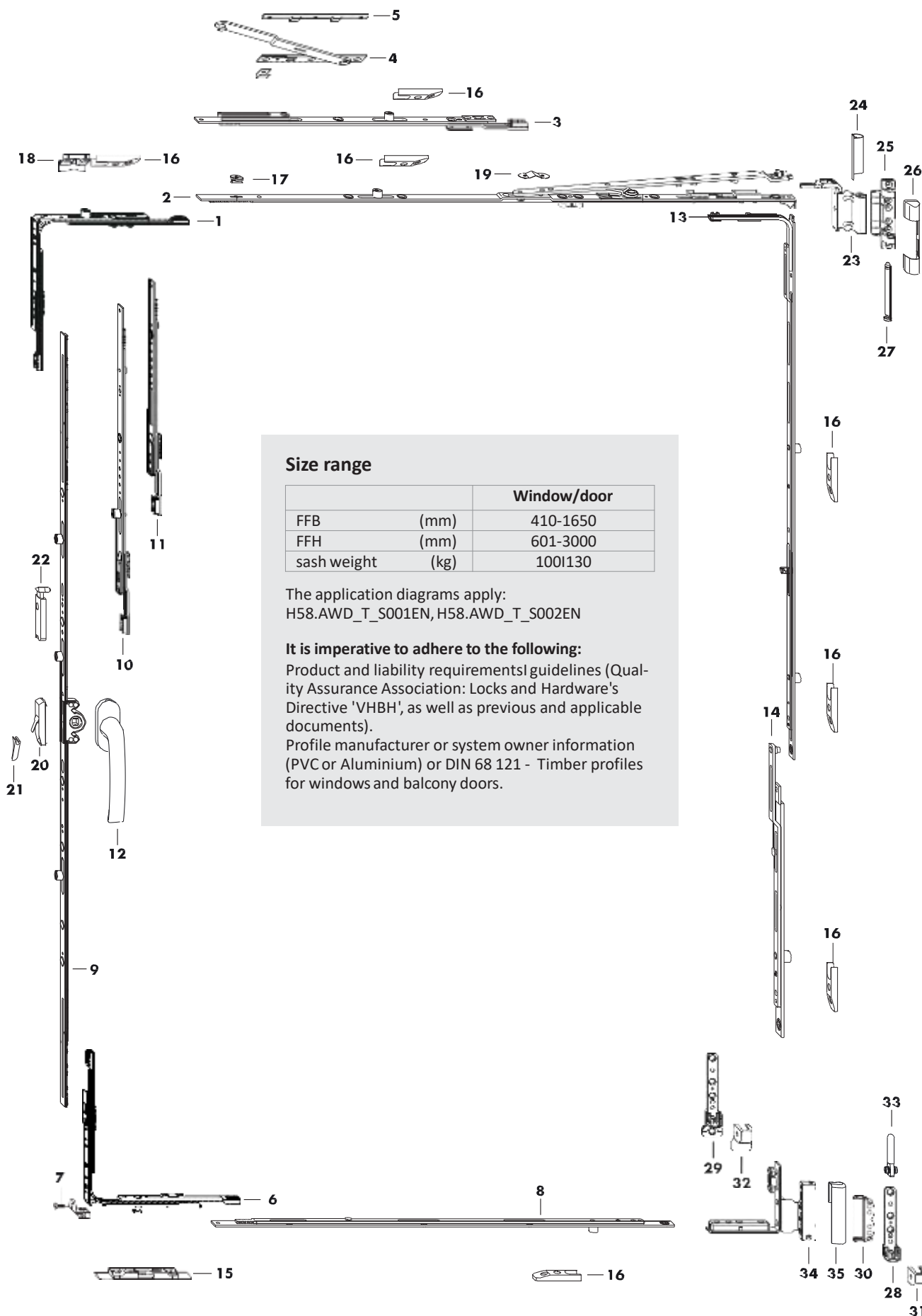

Size range

		Window/door
FFB	(mm)	410-1650
FFH	(mm)	601-3000
sash weight	(kg)	100 130

The application diagrams apply:
H58.AWD_T_S001EN, H58.AWD_T_S002EN

It is imperative to adhere to the following:

Product and liability requirements| guidelines (Quality Assurance Association: Locks and Hardware's Directive 'VHBH', as well as previous and applicable documents).

Profile manufacturer or system owner information (PVC or Aluminium) or DIN 68 121 - Timber profiles for windows and balcony doors.

6

List of fittings slave sash

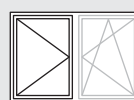
2-sash square tilt-turn turn DSG gear
H12 GM Hinge side Si-line

Pos.	Description	Part number	QTY	FFB	FFH	Dimension G	Number of frame parts / Pos.			
						In the main sash	46	47	48	49
36	corn.drive VSO ..	FEUL0230- ...	1	410- 1650					1	
37	centre lock sz 50	700969	2	1031- 1260					2	
	centre lock sz 70	700976		1261- 1490				2		
	centre lock sz 90	700983		1491- 1650				2		
	stay 7 DF	707340		410- 1650						
38	stay 7 DF	707340	1	410- 1650						
39	corn.drive FAV VS 1S ..	FEUL0510- ...	1	410- 1650			1			
40	sash lift S-ES	Ref. PDB, FMFH	1	410- 1650						
41	s.sash gear16 FAV 60I300	FGKS4030- ...	1		601- 800	300- 400				
	sec.sash gear16 FAV sz .80 1SB	FGMS4040- ...			801- 1000	400- 500				
	sec.sash gear16 FAV sz .80 1SB	FGMS4040- ...			1001- 1200	500- 600	1			
	sec.sash gear16 FAV sz 120 1SB	FGMS4050- ...			1201- 1400	600- 700	1			
	sec.sash gear16 FAV sz 120 2SB	FGMS4120- ...			1401- 1600	700- 800	1			
	sec.sash gear16 FAV sz 160 2SB	FGMS4130- ...			1601- 2000	800- 1000	1			
	sec.sash gear16 FAV sz 200 3SB	FGMS4100- ...			2001- 2400	1000- 1200	1			
	sec.sash gear16 FAV sz 200 3SB	FGMS4100- ...			2401- 3000	1200	1			
42	linkage FAV sz 200 A0767	FZSZ0120- ...	1		2401- 2600					1
	linkage FAV sz 400 A0767	FZSZ0130- ...			2601- 3000					1
43	linkage FAV sz 200 A0767	FZSZ0120- ...	1		2801- 3000					
44	sash part MV	Ref. PDB, ZFMV01	1		1001- 1600					
	sash part MV	Ref. PDB, ZFMV01	2		1601- 2400					
	sash part MV	Ref. PDB, ZFMV01	3		2401- 3000					
45	frame part MV	Ref. PDB, ZRZM01	1		1001- 1600					
	frame part MV	Ref. PDB, ZRZM01	2		1601- 2400					
	frame part MV	Ref. PDB, ZRZM01	3		2401- 3000					
46	tilt lock bear. S-ES FH	Ref. PDB, FRKA								
47	striker plate f. gear MV	Ref. PDB, FRSA02								
48	striker plate 56	Ref. PDB, FRSB								
49	striker plate 56 A0767	TRSB0020- ...								
on request										
50	stop	Ref. PDB, FRZF04	1		801- 3000					
51	striker snapper A0767	TRST0010- ...	1		1801- 3000					

Pos.	Description	Hinge side turning points				required as per sash weight	
		Part number			100 kg	130 kg	
		surface TS	RAL9016	RAL8022			
52	stay hinge	Ref. PDB, FBWB			1	1	
53	cover cap W timber		FKWB0020-004 ...	FKWB0020-012 ...	1	1	
54	top hinge S	Ref. PDB, FBLS02			1	1	
55	cover cap S		FKSL0010-004 ...	FKSL0010-012 ...	1	1	
56	top hinge pin diam.6	FBSB0010-1 ...			1	1	
57	bottom hinge	Ref. PDB, FBEL01			1		
58	bottom hinge S	Ref. PDB, FBEL02				1	
59	filling piece H timber	Ref. PDB, FBFS			1	1	
60	cover cap EL U		FKEU0010-004 ...	FKEU0010-012 ...	1		
61	cover cap EL-S U		FKEL0010-004 ...	FKEL0010-012 ...		1	
62	bottom hinge pin diam.6	TBLB0010-1 ...			1	1	
63	reb.cor.hinge	Ref. PDB, TBFE81			1	1	
64	cover cap FEB rh.		TKFE7011-004 ...	TKFE7011-012 ...	1	1	
	cover cap FEB lh.		TKFE7012-004 ...	TKFE7012-012 ...	1	1	

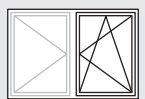

List of fittings main sash

2-sash square tilt-turn turn DSG gear
H12 GM Hinge side Si-line

FAVORIT

GS

Pos.	Description	Part number	QTY	FFB	FFH	Dimension G	Number of frame parts / Pos.	
							15	16
1a	corn.drive narrow VSO ..	FEUL0520- ...	1	410- 410				
1b	corn.drive VSO ..	FEUL0230- ...	1	411- 1650				1
2	stay 7 sz 30	707302	1	410- 620				
	stay 7 sz 35 MV	707319		621- 800				
	stay 7 sz 50 MV	707326		801- 1030				
	stay 7 sz 55 MV	707333		1031- 1260				1
	stay 7 sz 50 MV	707326		1261- 1490				1
	stay 7 sz 55 MV	707333		1491- 1650				1
3	linkage SIZ FAV 1V	FZOK0100- ...	1	1261- 1650				1
4	additional stay	Ref. PDB, TSZS	1	1261- 1650				
5	packer Z	Ref. PDB, FRUP01	1	1261- 1650				
6	corn.drive FAV VS 1S ..	FEUL0510- ...	1	410- 1650			1	
7	sash lift S-ES	Ref. PDB, FMFH	1	410- 1650				
8	centre lock sz 50	700969	1	1031- 1260				1
	centre lock sz 70	700976		1261- 1490				1
	centre lock sz 90	700983		1491- 1650				1
9	gear 15 FAV sz 60	FGMK4020- ...	1		601- 800	300- 400		
	gear 15 FAV sz 80 1V	FGMK4040- ...			801- 1000	400- 500		
	gear 15 FAV sz 80 1V	FGMK4040- ...			1001- 1200	500- 600		
	gear 15 FAV sz 120 1V	FGMK4050- ...			1201- 1400	600- 700		
	gear 15 FAV sz 120 2V	FGMK4070- ...			1401- 1600	700- 800		
	gear 15 FAV sz 160 2V	FGMK4060- ...			1601- 2000	800- 1000		
	gear 15 FAV sz 200 3V	FGMK4110- ...			2001- 2400	1000- 1200		
	gear 15 FAV sz 200 3V	FGMK4110- ...			2401- 3000	1200		
10	linkage FAV sz 200 A0767	FZSZ0120- ...	1		2401- 2600			
	linkage FAV sz 400 1V	FZSZ0110- ...			2601- 3000			
11	linkage FAV sz 200 A0767	FZSZ0120- ...	1		2801- 3000			
12	handle Globe	Ref.access. ZHGS	1		601- 3000			
13	corn.drive VSU BS sz 50 1V ..	FEUL2070- ...	1		1001- 1200			1
	corn.drive VSU BS sz 70 1V ..	FEUL2080- ...			1201- 1600			1
	corn.drive VSU BS sz 90 1V ..	FEUL2090- ...			1601- 2000			1
	corn.drive BS sz 130 2V ..	FEUL2630- ...			2001- 3000			2
14	MV extension sz 60	700952	1		2401- 3000			1
15	tilt lock bear. S-ES FH	Ref. PDB, FRKA						
16	striker plate 56	Ref. PDB, FRSB						
on request								
17	location piece ..	702543	1					
18	frame part SP-S	Ref. PDB, FRZL01	1	411- 1650				
19	tilt restrictor ..	805701	1		601- 800			
20	mishandling device FAV.	FFBS0110- ...	1		801- 3000			
21	pressure piece	Ref. PDB, TFFD	1		801- 3000			
22	snapper switchable rh.	TFST0011- ...	1		1601- 3000			
	snapper switchable lh.	TFST0012- ...			1601- 3000			

Pos.	Description	Hinge side turning points				required as per sash weight	
		Part number			100 kg	130 kg	
		surface TS	RAL9016	RAL8022			
23	stay hinge	Ref. PDB, FBWB			1	1	
24	cover cap W timber		FKWB0020-004 ...	FKWB0020-012 ...	1	1	
25	top hinge S	Ref. PDB, FBSL02			1	1	
26	cover cap S		FKSL0010-004 ...	FKSL0010-012 ...	1	1	
27	top hinge pin diam.6	FBSB0010-1 ...			1	1	
28	bottom hinge	Ref. PDB, FBEL01			1		
29	bottom hinge S	Ref. PDB, FBEL02				1	
30	filling piece H timber	Ref. PDB, FBFS			1	1	
31	cover cap EL U		FKEU0010-004 ...	FKEU0010-012 ...	1		
32	cover cap EL-S U		FKEL0010-004 ...	FKEL0010-012 ...		1	
33	bottom hinge pin diam.6	TBLB0010-1 ...			1	1	
34	reb.cor.hinge	Ref. PDB, TBFE81			1	1	
35	cover cap FEB rh.		TKFE7011-004 ...	TKFE7011-012 ...	1	1	
	cover cap FEB lh.		TKFE7012-004 ...	TKFE7012-012 ...	1	1	

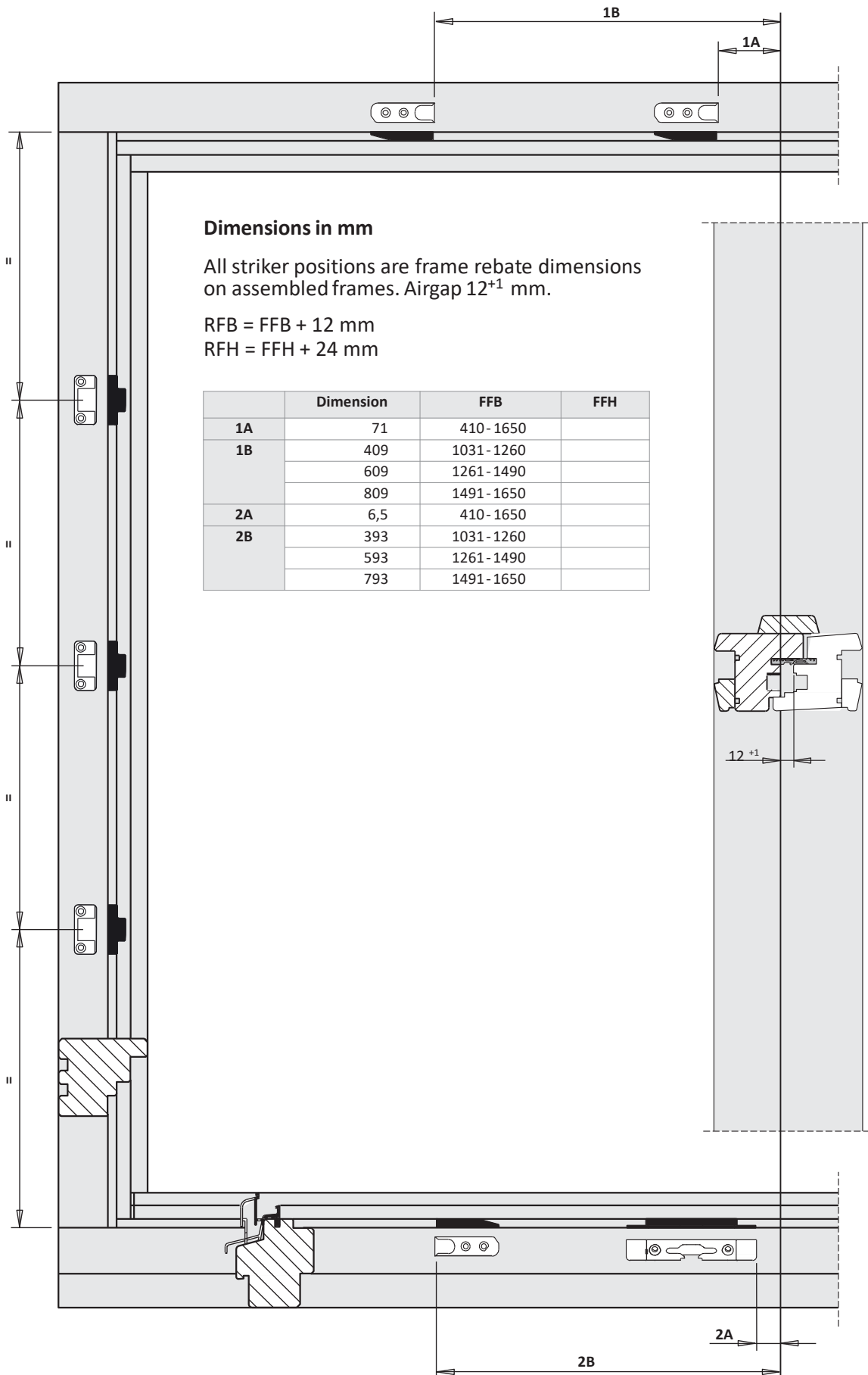
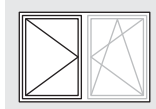

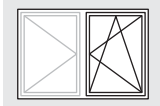

Frame dimensions main sash
 2-sash square tilt-turn turn DSG gear
 H12 GM Hinge side Si-line

FAVORIT

GS

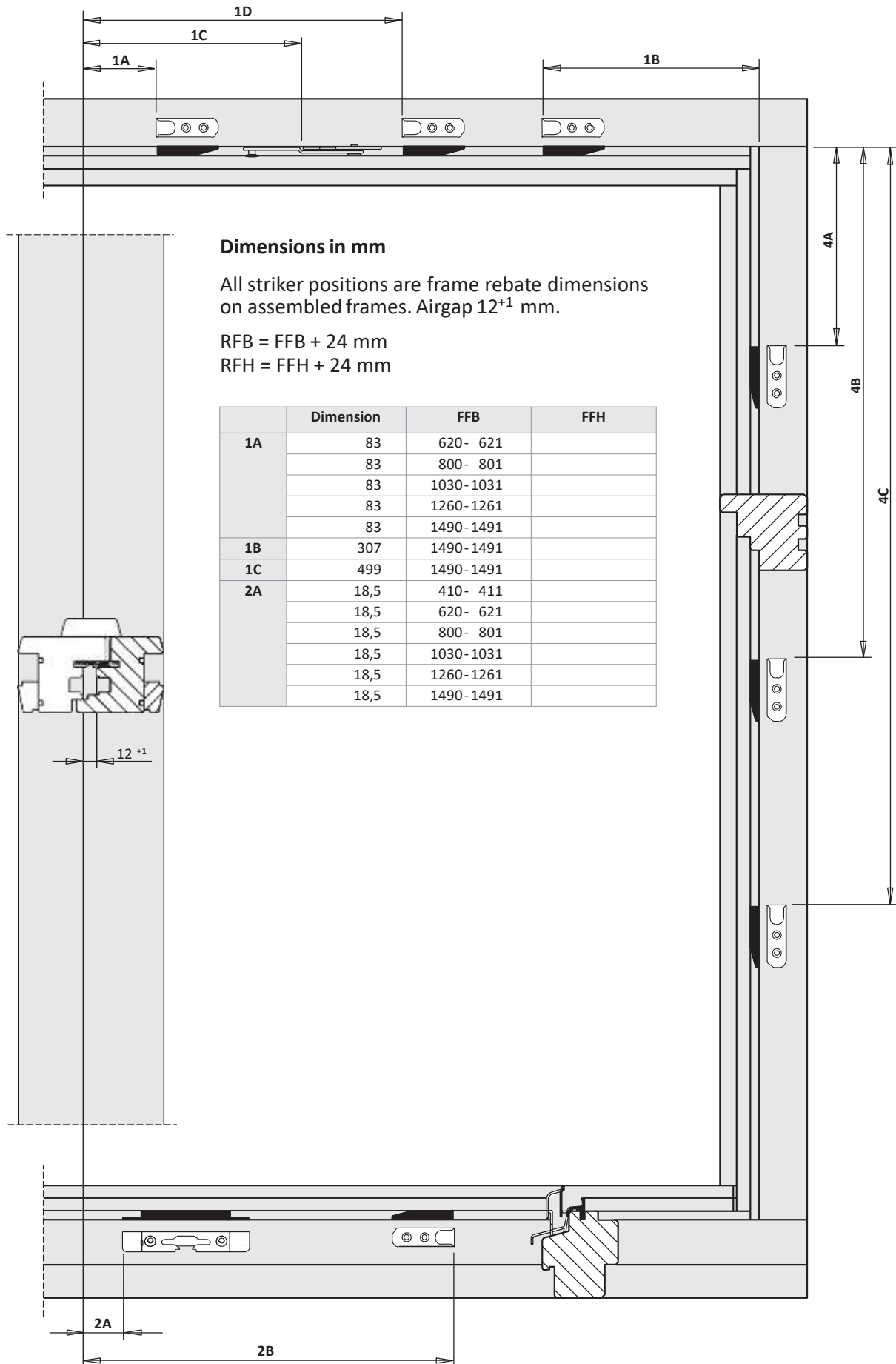

6

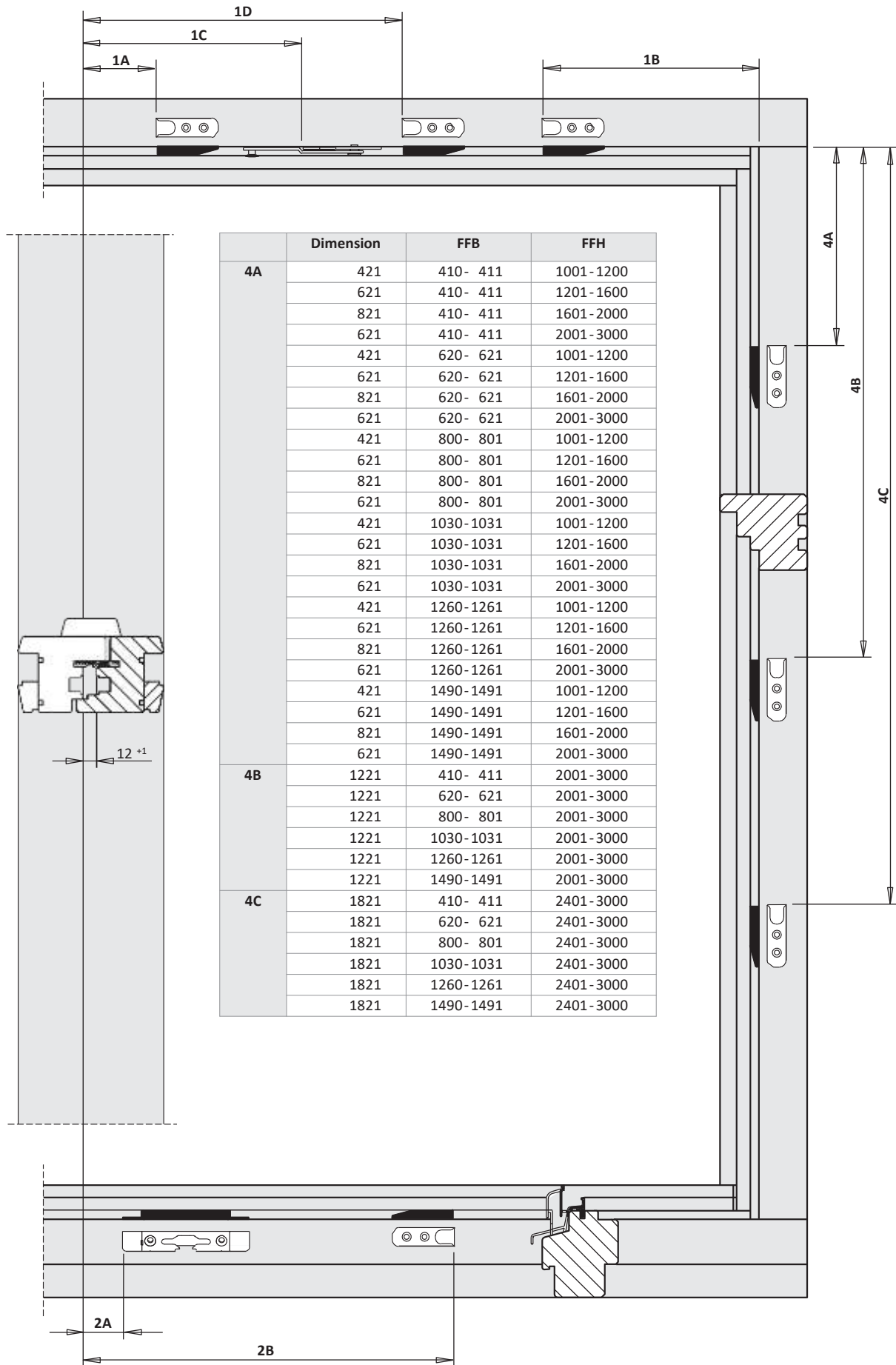
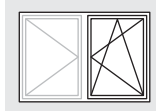

	Dimension	FFB	FFH	
4A	421	410- 411	1001-1200	
	621	410- 411	1201-1600	
	821	410- 411	1601-2000	
	621	410- 411	2001-3000	
	421	620- 621	1001-1200	
	621	620- 621	1201-1600	
	821	620- 621	1601-2000	
	621	620- 621	2001-3000	
	421	800- 801	1001-1200	
	621	800- 801	1201-1600	
	821	800- 801	1601-2000	
	621	800- 801	2001-3000	
	421	1030-1031	1001-1200	
	621	1030-1031	1201-1600	
	821	1030-1031	1601-2000	
	621	1030-1031	2001-3000	
	4B	421	1260-1261	1001-1200
		621	1260-1261	1201-1600
821		1260-1261	1601-2000	
621		1260-1261	2001-3000	
421		1490-1491	1001-1200	
621		1490-1491	1201-1600	
821		1490-1491	1601-2000	
621		1490-1491	2001-3000	
421		1221	410- 411	2001-3000
621		1221	620- 621	2001-3000
821		1221	800- 801	2001-3000
621		1221	1030-1031	2001-3000
4C	1821	1260-1261	2001-3000	
	1821	1490-1491	2001-3000	
	1821	410- 411	2401-3000	
	1821	620- 621	2401-3000	
	1821	800- 801	2401-3000	
	1821	1030-1031	2401-3000	

FAVORIT

Installation instructions

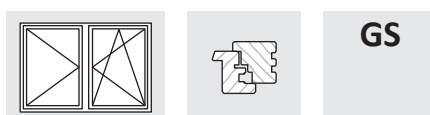

2-sash square tilt-turn turn shoot bolt

timber 12 mm

basic security

centre handle pos. (variable)

Hinge side Si-line

surface TS

backset 15 mm

6

Hardware set configuration	
General	Locking-points distance 1000
Stay side	one-piece stay
Bottom	loose sash lift
Locking side	mishandl. device on gear
Hinge side	corner drive BS 2V
Hinge side turning points	loose filling pc I pre-mounted

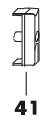
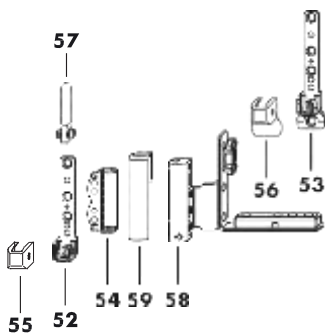
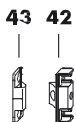
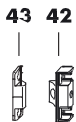
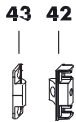
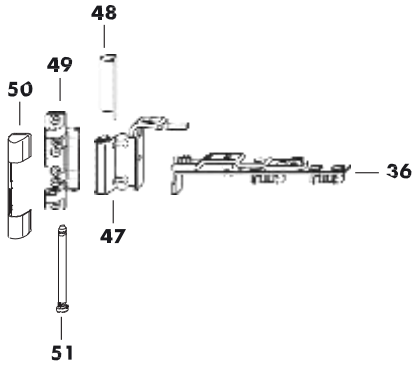
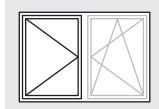

Size range

		Window/door
FFB	(mm)	230-800
FFH	(mm)	320-3000
sash weight	(kg)	100 130

The application diagrams apply:
H58.AWD_T_S001EN, H58.AWD_T_S002EN

It is imperative to adhere to the following:

Product and liability requirements| guidelines (Quality Assurance Association: Locks and Hardware's Directive 'VHBH', as well as previous and applicable documents).

Profile manufacturer or system owner information (PVC or Aluminium) or DIN 68 121 - Timber profiles for windows and balcony doors.

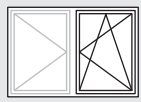

hardware layout main sash

2-sash square tilt-turn turn shoot bolt

H12 GM Hinge side Si-line

FAVORIT

GS

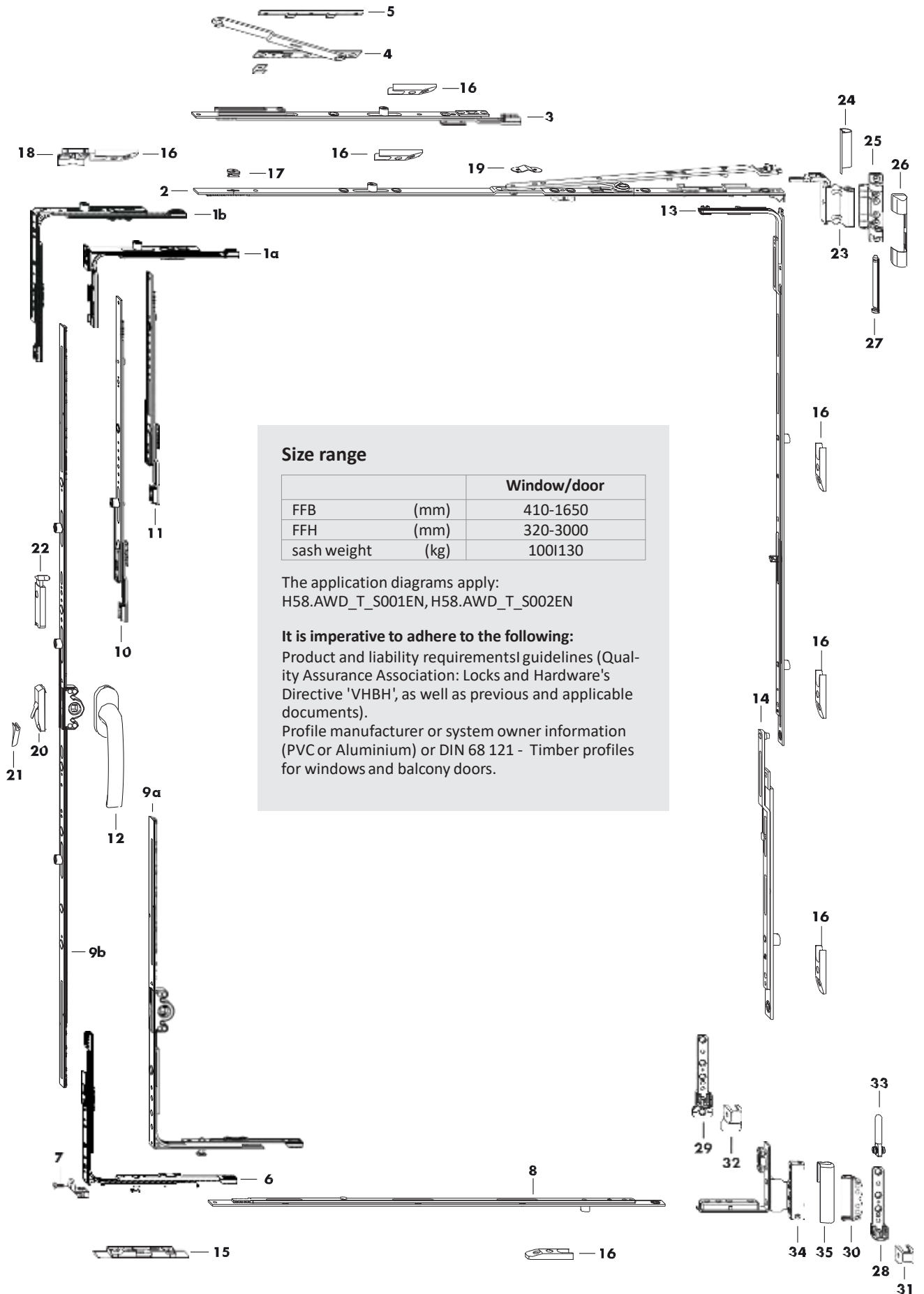

6

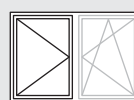

Pos.	Description	Part number	QTY	FFB	FFH	Dimension G	Number of frame parts / Pos.
						In the main sash	44
36	stay 7 DF	707340	1	230- 800			
37	sash lift .. A2000	TFFH0010- ...	1	230- 800			
38	run-up FHITiP	Ref. PDB, TRAL	1	230- 800			
39	short shoot bolt A2000	716236	2		320-3000		2
40	striker plate 56 A2000	TRSB0030- ...	1		1001-1200	500- 600	
	striker plate 56 A2000	TRSB0030- ...			1201-1600	600- 800	
	striker plate 56 A2000	TRSB0030- ...			1601-2000	800-1000	
	striker plate 56 A2000	TRSB0030- ...	2		2001-2400	1000-1200	
	striker plate 56 A2000	TRSB0030- ...			2401-2600	1200	
41	striker plate 56 A2000	TRSB0030- ...	3		2601-3000	1200	
42	sash part MV	Ref. PDB, ZFMV01	1		1001-1600		
	sash part MV	Ref. PDB, ZFMV01	2		1601-2400		
	sash part MV	Ref. PDB, ZFMV01	3		2401-3000		
43	frame part MV	Ref. PDB, ZRZM01	1		1001-1600		
	frame part MV	Ref. PDB, ZRZM01	2		1601-2400		
	frame part MV	Ref. PDB, ZRZM01	3		2401-3000		
44	striker V	Ref. PDB, FRZV01					
on request							
45	stop 2,2mm	710937	1		801-3000		
46	striker plate 56 A2000	TRSB0030- ...	1		1601-3000		

Hinge side turning points						
Pos.	Description	Part number			required as per sash weight	
		surface TS	RAL9016	RAL8022	100 kg	130 kg
47	stay hinge	Ref. PDB, FBWB			1	1
48	cover cap W timber		FKWB0020-004 ...	FKWB0020-012 ...	1	1
49	top hinge S	Ref. PDB, FBLS02			1	1
50	cover cap S		FKSL0010-004 ...	FKSL0010-012 ...	1	1
51	top hinge pin diam.6	FBSB0010-1 ...			1	1
52	bottom hinge	Ref. PDB, FBEL01			1	
53	bottom hinge S	Ref. PDB, FBEL02				1
54	filling piece H timber	Ref. PDB, FBFS			1	1
55	cover cap EL U		FKEU0010-004 ...	FKEU0010-012 ...	1	
56	cover cap EL-S U		FKEL0010-004 ...	FKEL0010-012 ...		1
57	bottom hinge pin diam.6	TBLB0010-1 ...			1	1
58	reb.cor.hinge	Ref. PDB, TBF81			1	1
59	cover cap FEB rh.		TKFE7011-004 ...	TKFE7011-012 ...	1	1
	cover cap FEB lh.		TKFE7012-004 ...	TKFE7012-012 ...	1	1

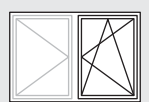

List of fittings main sash

2-sash square tilt-turn turn shoot bolt

H12 GM Hinge side Si-line

FAVORIT
GS

Pos.	Description	Part number	QTY	FFB	FFH	Dimension G	Number of frame parts / Pos.	
							15	16
1a	corn.drive narrow VSO ..	FEUL0520- ...	1	410- 800	320- 430			1
1b	corn.drive VSO ..	FEUL0230- ...	1	410-1650	431-3000			1
2	stay 7 sz 30	707302	1	410- 620				
	stay 7 sz 35 MV	707319		621- 800				
	stay 7 sz 50 MV	707326		801-1030				
	stay 7 sz 55 MV	707333		1031-1260				1
	stay 7 sz 50 MV	707326		1261-1490				1
	stay 7 sz 55 MV	707333		1491-1650				1
3	linkage SIZ FAV 1V	FZOK0100- ...	1	1261-1650				1
4	additional stay	Ref. PDB, TSZS	1	1261-1650				
5	packer Z	Ref. PDB, FRUP01	1	1261-1650				
6	corn.drive FAV VS 1S ..	FEUL0510- ...	1	410-1650	601-3000		1	
7	sash lift S-ES	Ref. PDB, FMFH	1	410-1650				
8	centre lock sz 50	700969	1	1031-1260				1
	centre lock sz 70	700976		1261-1490				1
	centre lock sz 90	700983		1491-1650				1
9a	gear 15 FAV sz 30IG180 S-ES	FGKK4020- ...	1	410- 800	320- 430	180	1	
	gear 15 FAV sz 30IG180 S-ES	FGKK4020- ...			431- 600	180	1	
9b	gear 15 FAV sz 60	FGMK4020- ...	1		601- 800	300- 400		
	gear 15 FAV sz 80 1V	FGMK4040- ...			801-1000	400- 500		
	gear 15 FAV sz 80 1V	FGMK4040- ...			1001-1200	500- 600		
	gear 15 FAV sz 120 1V	FGMK4050- ...			1201-1400	600- 700		
	gear 15 FAV sz 120 2V	FGMK4070- ...			1401-1600	700- 800		
	gear 15 FAV sz 160 2V	FGMK4060- ...			1601-2000	800-1000		
	gear 15 FAV sz 200 3V	FGMK4110- ...			2001-2400	1000-1200		
	gear 15 FAV sz 200 3V	FGMK4110- ...			2401-3000	1200		
10	linkage FAV sz 200 A0767	FZSZ0120- ...	1		2401-2600			
	linkage FAV sz 400 1V	FZSZ0110- ...			2601-3000			
11	linkage FAV sz 200 A0767	FZSZ0120- ...	1		2801-3000			
12	handle Globe	Ref.access. ZHGS	1		320-3000			
13	corn.drive VSU BS sz 50 1V ..	FEUL2070- ...	1		1001-1200			1
	corn.drive VSU BS sz 70 1V ..	FEUL2080- ...			1201-1600			1
	corn.drive VSU BS sz 90 1V ..	FEUL2090- ...			1601-2000			1
	corn.drive BS sz 130 2V ..	FEUL2630- ...			2001-3000			2
14	MV extension sz 60	700952	1		2401-3000			1
15	tilt lock bear. S-ES FH	Ref. PDB, FRKA						
16	striker plate 56	Ref. PDB, FRSB						
on request								
17	location piece ..	702543	1					
18	frame part SP-S	Ref. PDB, FRZL01	1					
19	tilt restrictor ..	805701	1		320- 800			
20	mishandling device FAV.	FFBS0110- ...	1		801-3000			
21	pressure piece	Ref. PDB, TFFD	1		801-3000			
22	snapper switchable rh.	TFST0011- ...	1		1601-3000			
	snapper switchable lh.	TFST0012- ...			1601-3000			

Hinge side turning points						
Pos.	Description	Part number			required as per sash weight	
		surface TS	RAL9016	RAL8022	100 kg	130 kg
23	stay hinge	Ref. PDB, FBWB			1	1
24	cover cap W timber		FKWB0020-004 ...	FKWB0020-012 ...	1	1
25	top hinge S	Ref. PDB, FBLS02			1	1
26	cover cap S		FKSL0010-004 ...	FKSL0010-012 ...	1	1
27	top hinge pin diam.6	FBSB0010-1 ...			1	1
28	bottom hinge	Ref. PDB, FBEL01			1	
29	bottom hinge S	Ref. PDB, FBEL02				1
30	filling piece H timber	Ref. PDB, FBFS			1	1
31	cover cap EL U		FKEU0010-004 ...	FKEU0010-012 ...	1	
32	cover cap EL-S U		FKEL0010-004 ...	FKEL0010-012 ...		1
33	bottom hinge pin diam.6	TBLB0010-1 ...			1	1
34	reb.cor.hinge	Ref. PDB, TBFE81			1	1
35	cover cap FEB rh.		TKFE7011-004 ...	TKFE7011-012 ...	1	1
	cover cap FEB lh.		TKFE7012-004 ...	TKFE7012-012 ...	1	1

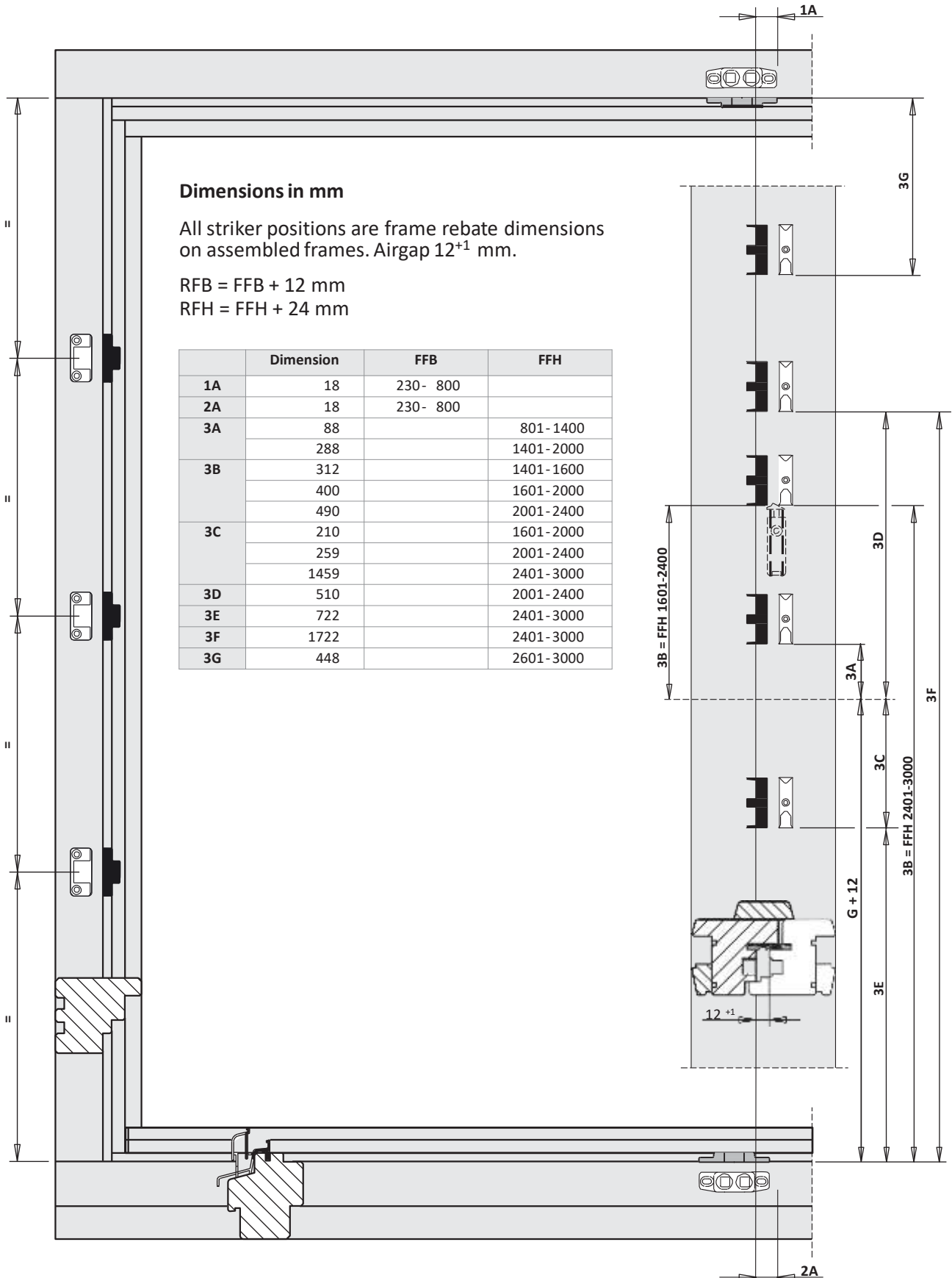
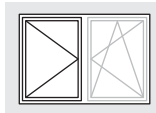

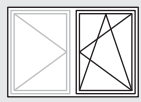

Frame dimensions main sash
2-sash square tilt-turn turn shoot bolt
H12 GM Hinge side Si-line

FAVORIT

GS

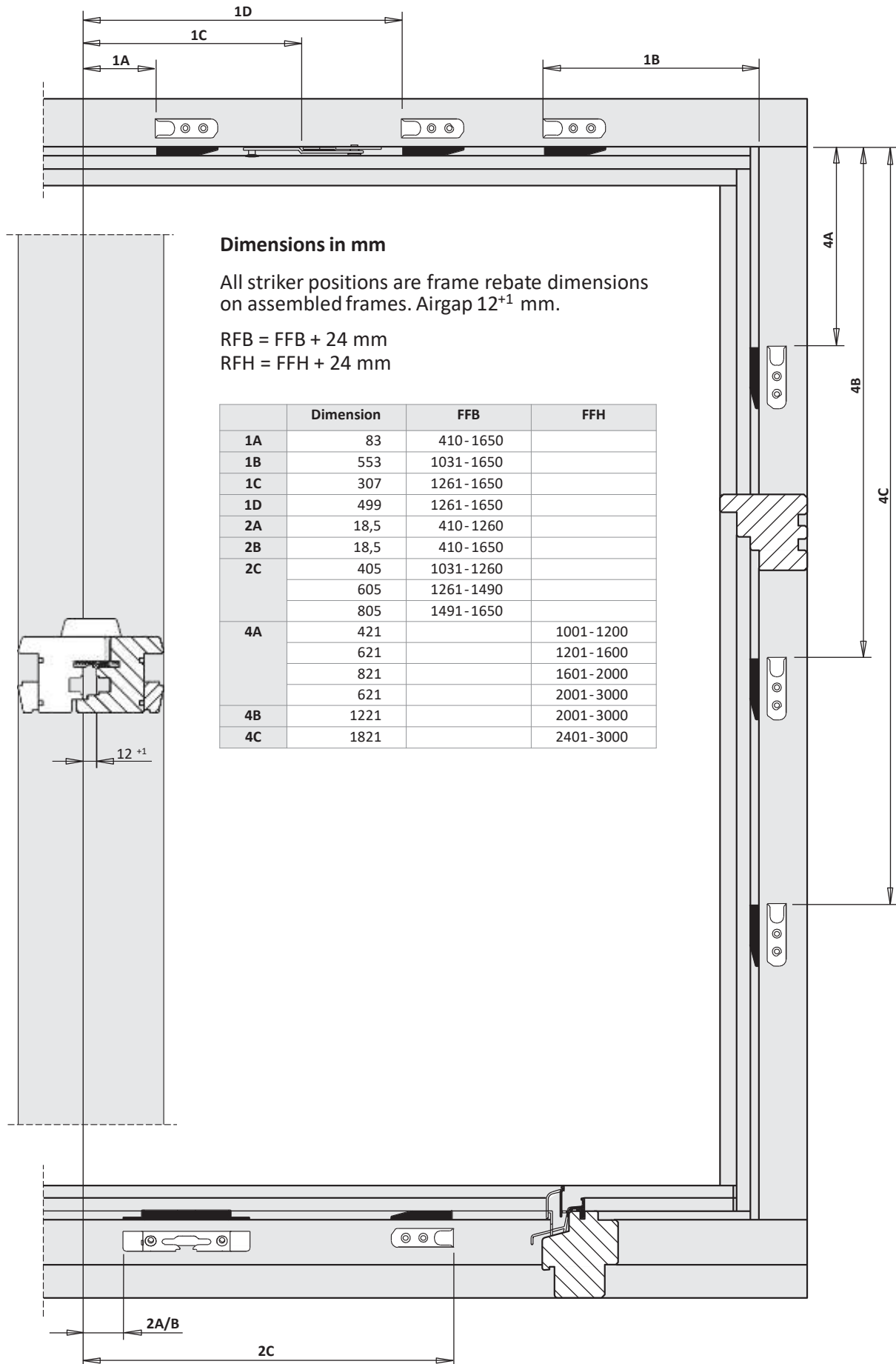

6

FAVORIT

Installation instructions



1-sash square tilt before turn (TBT)

timber 12 mm

basic security

centre handle pos. (variable)

Hinge side Si-line

surface TS

backset 15 mm

6

Hardware set configuration	
General	Locking-points distance 1000
Stay side	one-piece stay
Bottom	loose sash lift
Locking side	mishandl. device on gear
Hinge side	corner drive BS 2V
Hinge side turning points	loose filling pc I pre-mounted

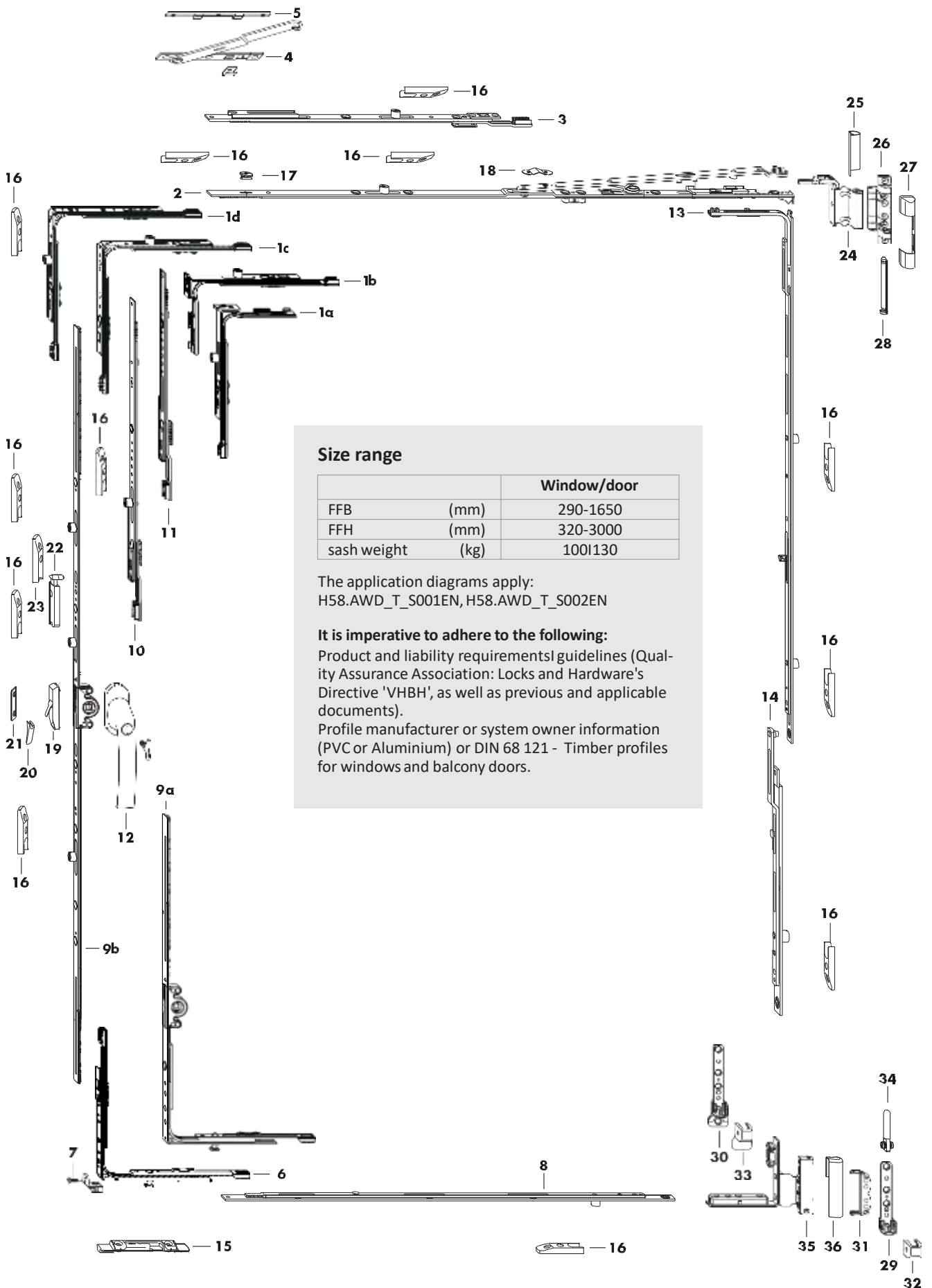
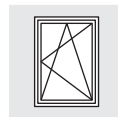

Size range

		Window/door
FFB	(mm)	290-1650
FFH	(mm)	320-3000
sash weight	(kg)	100 130

The application diagrams apply:
H58.AWD_T_S001EN, H58.AWD_T_S002EN

It is imperative to adhere to the following:
Product and liability requirements | guidelines (Quality Assurance Association: Locks and Hardware's Directive 'VHBH', as well as previous and applicable documents).
Profile manufacturer or system owner information (PVC or Aluminium) or DIN 68 121 - Timber profiles for windows and balcony doors.



List of fittings
1-sash square tilt before turn (TBT)
H12 GM Hinge side Si-line

FAVORIT

GS

Pos.	Description	Part number	QTY	FFB	FFH	Dimension G	Number of frame parts / Pos.	
							15	16
1a	corn.drive narrow VSO ..	FEUL0520- ...	1	290- 410	431-3000			1
1b	corn.drive narrow VSO ..	FEUL0520- ...	1	411- 800	320- 430			1
1c	corn.drive VSO ..	FEUL0230- ...	1	411- 1260	431-3000			1
1d	corn.drive VSO ..	FEUL0230- ...	1	1261- 1650	431-3000			1
2	stay 7 TBT sz 30	707357	1	290- 620				
	stay 7 TBT sz 35 MV	707364		621- 800				
	stay 7 TBT sz 50 MV	707371		801- 1030				
	stay 7 TBT sz 55 MV	707388		1031- 1260				1
	stay 7 TBT sz 50 MV	707371		1261- 1490				1
	stay 7 TBT sz 55 MV	707388		1491- 1650				1
3	linkage SIZ TBT FAV 1V	FZOT0100- ...	1	1261- 1650				1
4	additional stay	Ref. PDB, TSZS	1	1261- 1650				
5	packer Z	Ref. PDB, FRUP01	1	1261- 1650				
6	corn.drive FAV VS 1S ..	FEUL0510- ...	1	290- 1650	601-3000		1	
7	sash lift S-ES	Ref. PDB, FMFH	1	290- 1650				
8	centre lock sz 50	700969	1	1031- 1260				1
	centre lock sz 70	700976		1261- 1490				1
	centre lock sz 90	700983		1491- 1650				1
9a	gear 15 FAV sz 30IG180 S-ES	FGKK4020- ...	1	411- 800	320- 430	180	1	
	gear 15 FAV sz 30IG180 S-ES	FGKK4020- ...		431- 600	180	1		
9b	gear 15 FAV sz 60	FGMK4020- ...	1		601- 800	300- 400		
	gear 15 FAV sz 80 1V	FGMK4040- ...		801- 1000	400- 500			
	gear 15 FAV sz 80 1V	FGMK4040- ...		1001- 1200	500- 600		1	
	gear 15 FAV sz 120 1V	FGMK4050- ...		1201- 1400	600- 700		1	
	gear 15 FAV sz 120 2V	FGMK4070- ...		1401- 1600	700- 800		2	
	gear 15 FAV sz 160 2V	FGMK4060- ...		1601- 2000	800- 1000		2	
	gear 15 FAV sz 200 3V	FGMK4110- ...		2001- 2400	1000- 1200		2	
	gear 15 FAV sz 200 3V	FGMK4110- ...		2401- 3000	1200		2	
10	linkage FAV sz 200 A0767	FZSZ0120- ...	1		2401- 2600			
	linkage FAV sz 400 1V	FZSZ0110- ...		2601- 3000			1	
11	linkage FAV sz 200 A0767	FZSZ0120- ...	1		2801- 3000			
12	handle Globe TBT lockable	Ref.access. ZHGT	1		320- 3000			
13	corn.drive VSU BS sz 50 1V ..	FEUL2070- ...	1		1001- 1200			1
	corn.drive VSU BS sz 70 1V ..	FEUL2080- ...		1201- 1600			1	
	corn.drive VSU BS sz 90 1V ..	FEUL2090- ...		1601- 2000			1	
	corn.drive BS sz 130 2V ..	FEUL2630- ...		2001- 3000			2	
14	MV extension sz 60	700952	1		2401- 3000			1
15	tilt lock bear. S-ES FH TBT	Ref. PDB, FRKB						
16	striker plate 56	Ref. PDB, FRSB						
on request								
17	location piece ..	702543	1					
18	tilt restrictor ..	805701	1		320- 800			
19	mishandling device FAV.	FFBS0110- ...	1					
20	pressure piece	Ref. PDB, TFFD	1					
21	stop	Ref. PDB, FRZF01	1					
22	snapper switchable rh.	TFST0011- ...	1		1601- 3000			
	snapper switchable lh.	TFST0012- ...		1601- 3000				
23	frame part snapper	Ref. PDB, TRST	1		1601- 3000			



Pos.	Description	Hinge side turning points			required as per sash weight	
		surface TS	Part number		100 kg	130 kg
			RAL9016	RAL8022		
24	stay hinge	Ref. PDB, FBWB			1	1
25	cover cap W timber		FKWB0020-004 ...	FKWB0020-012 ...	1	1
26	top hinge S	Ref. PDB, FBSL02			1	1
27	cover cap S		FKSL0010-004 ...	FKSL0010-012 ...	1	1
28	top hinge pin diam.6	FBSB0010-1 ...			1	1
29	bottom hinge	Ref. PDB, FBEL01			1	
30	bottom hinge S	Ref. PDB, FBEL02				1
31	filling piece H timber	Ref. PDB, FBFS			1	1
32	cover cap EL U		FKEU0010-004 ...	FKEU0010-012 ...	1	
33	cover cap EL-S U		FKEL0010-004 ...	FKEL0010-012 ...		1
34	bottom hinge pin diam.6	TBLB0010-1 ...			1	1
35	reb.cor.hinge	Ref. PDB, TBFE81			1	1
36	cover cap FEB rh.		TKFE7011-004 ...	TKFE7011-012 ...	1	1
	cover cap FEB lh.		TKFE7012-004 ...	TKFE7012-012 ...	1	1



Frame dimensions

1-sash square tilt before turn (TBT)
H12 GM Hinge side Si-line

FAVORIT

GS

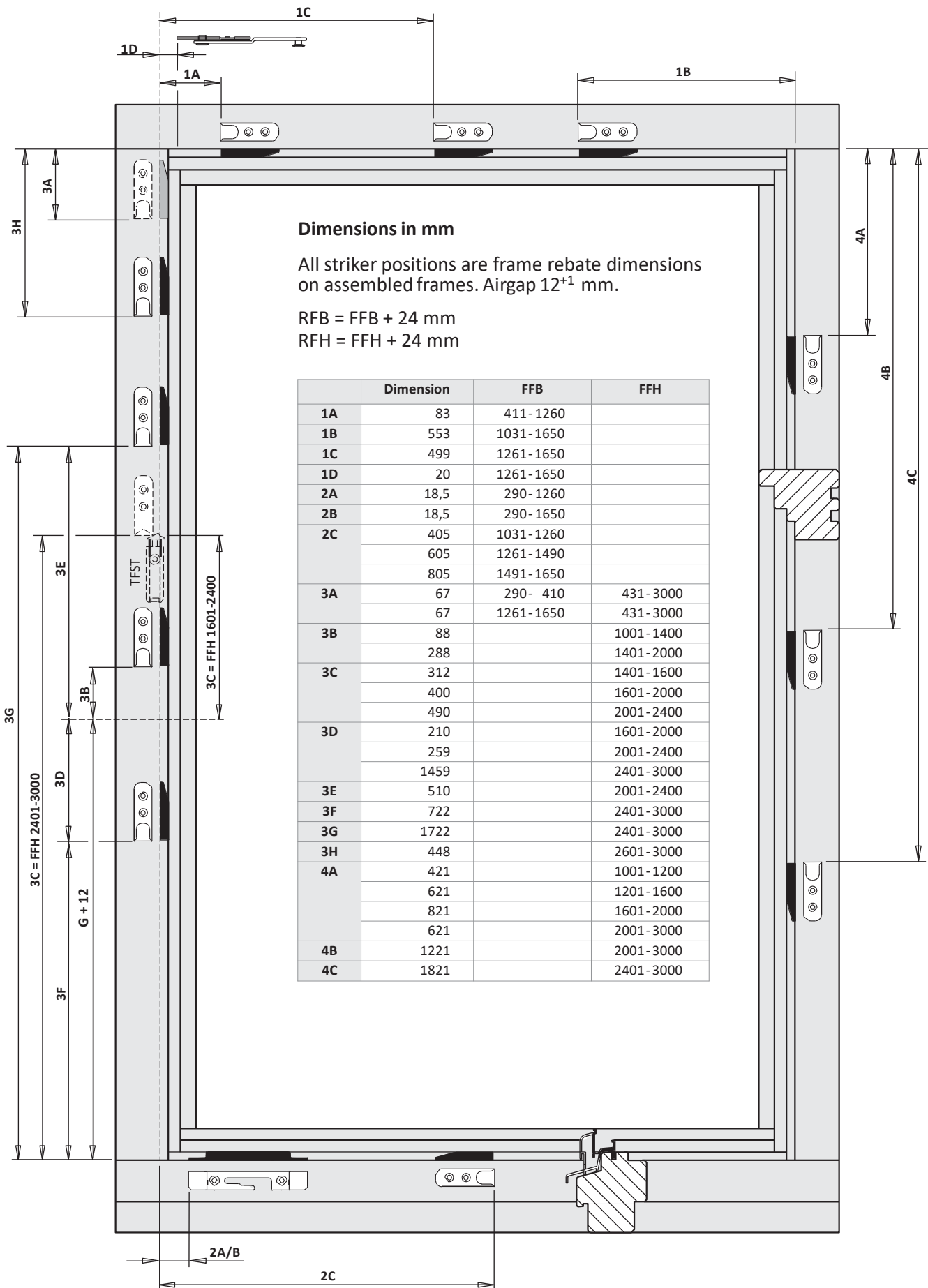

FAVORIT

Installation instructions



1-sash square tilt-turn

timber 12 mm

3-Punkt Sicherheit

centre handle pos. (variable)

Hinge side Si-line

surface TS

backset 15 mm

6

Hardware set configuration	
General	Locking-points distance 1000
Stay side	one-piece stay
Bottom	loose sash lift
Locking side	mishandl. device on gear
Hinge side	corner drive 1S 2V
Hinge side turning points	loose filling pc I pre-mounted

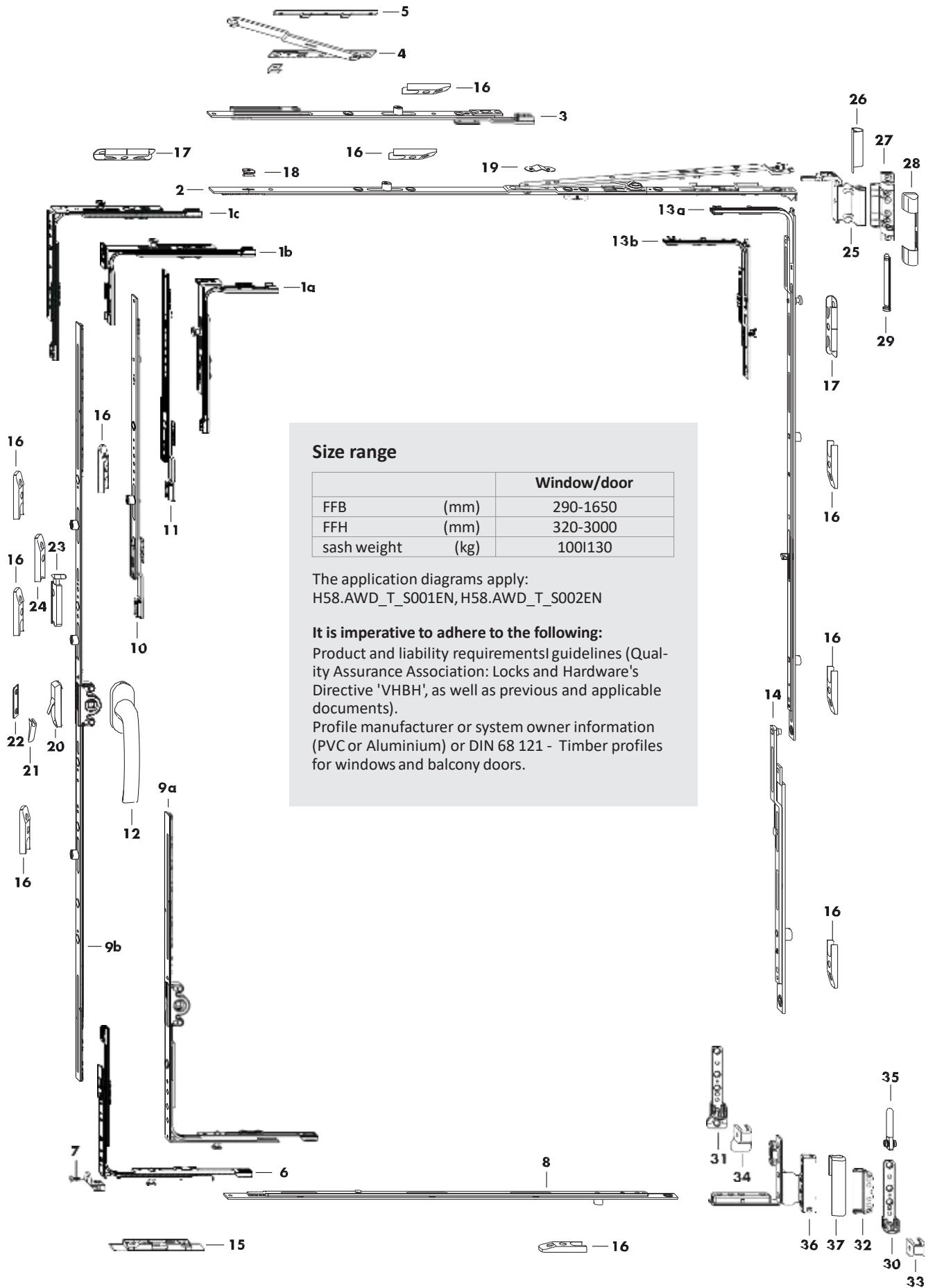

Size range

		Window/door
FFB	(mm)	290-1650
FFH	(mm)	320-3000
sash weight	(kg)	100 130

The application diagrams apply:
H58.AWD_T_S001EN, H58.AWD_T_S002EN

It is imperative to adhere to the following:

Product and liability requirements guidelines (Quality Assurance Association: Locks and Hardware's Directive 'VHBH', as well as previous and applicable documents).

Profile manufacturer or system owner information (PVC or Aluminium) or DIN 68 121 - Timber profiles for windows and balcony doors.



List of fittings
1-sash square tilt-turn
H12 GM Hinge side Si-line

FAVORIT

3P

Pos.	Description	Part number	QTY	FFB	FFH	Dimension G	Number of frame parts / Pos.		
							15	16	17
1a	corn.drive FAV VSO narrow 1S ..	FEUL0530- ...	1	290- 410	431-3000				1
1b	corn.drive FAV VSO narrow 1S ..	FEUL0530- ...	1	411- 800	320- 430				1
1c	corn.drive FAV VS 1S ..	FEUL0510- ...	1	411- 1650	431- 3000				1
2	stay 7 sz 30	707302	1	290- 620					
	stay 7 sz 35 MV	707319		621- 800					
	stay 7 sz 50 MV	707326		801- 1030					
	stay 7 sz 55 MV	707333		1031- 1260				1	
	stay 7 sz 50 MV	707326		1261- 1490				1	
	stay 7 sz 55 MV	707333		1491- 1650				1	
3	linkage SIZ FAV 1V	FZOK0100- ...	1	1261- 1650				1	
4	additional stay	Ref. PDB, TSZS	1	1261- 1650					
5	packer Z	Ref. PDB, FRUP01	1	1261- 1650					
6	corn.drive FAV VS 1S ..	FEUL0510- ...	1	290- 1650	601- 3000		1		
7	sash lift S-ES	Ref. PDB, FMFH	1	290- 1650					
8	centre lock sz 50	700969	1	1031- 1260				1	
	centre lock sz 70	700976		1261- 1490				1	
	centre lock sz 90	700983		1491- 1650				1	
9a	gear 15 FAV sz 30IG180 S-ES	FGKK4020- ...	1	411- 800	320- 430	180	1		
	gear 15 FAV sz 30IG180 S-ES	FGKK4020- ...			431- 600	180	1		
9b	gear 15 FAV sz 60	FGMK4020- ...	1		601- 800	300- 400			
	gear 15 FAV sz 80 1V	FGMK4040- ...			801- 1000	400- 500			
	gear 15 FAV sz 80 1V	FGMK4040- ...			1001- 1200	500- 600		1	
	gear 15 FAV sz 120 1V	FGMK4050- ...			1201- 1400	600- 700		1	
	gear 15 FAV sz 120 2V	FGMK4070- ...			1401- 1600	700- 800		2	
	gear 15 FAV sz 160 2V	FGMK4060- ...			1601- 2000	800- 1000		2	
	gear 15 FAV sz 200 3V	FGMK4110- ...			2001- 2400	1000- 1200		2	
	gear 15 FAV sz 200 3V	FGMK4110- ...			2401- 3000	1200		2	
10	linkage FAV sz 200 A0767	FZSZ0120- ...	1		2401- 2600				
	linkage FAV sz 400 1V	FZSZ0110- ...			2601- 3000			1	
11	linkage FAV sz 200 A0767	FZSZ0120- ...	1		2801- 3000				
12	handle Globe	Ref.access. ZHGS	1		320- 3000				
13a	corn.drive BS sz 20 1S ..	FEUL2100- ...	1		320- 1000				1
13b	corn.drive BS sz 50 1S 1V ..	FEUL2110- ...	1		1001- 1200			1	1
	corn.drive BS sz 70 1S 1V ..	FEUL2120- ...			1201- 1600			1	1
	corn.drive BS sz 90 1S 1V ..	FEUL2130- ...			1601- 2000			1	1
	corn.drive BS sz 130 1S 2V ..	FEUL2140- ...			2001- 3000			2	1
14	MV extension sz 60	700952	1		2401- 3000			1	
15	tilt lock bear. S-ES FH	Ref. PDB, FRKA							
16	striker plate 56	Ref. PDB, FRSB							
17	striker plate S-RS	Ref. PDB, TRSK							
on request									
18	location piece ..	702543	1						
19	tilt restrictor ..	805701	1		320- 800				
20	mishandling device FAV.	FFBS0110- ...	1						
21	pressure piece	Ref. PDB, TFFD	1						
22	stop	Ref. PDB, FRZF01	1						
23	snapper switchable rh.	TFST0011- ...	1		1601- 3000				
	snapper switchable lh.	TFST0012- ...			1601- 3000				
24	frame part snapper	Ref. PDB, TRST	1		1601- 3000				



Pos.	Description	Hinge side turning points			required as per sash weight	
		surface TS	Part number		100 kg	130 kg
			RAL9016	RAL8022		
25	stay hinge	Ref. PDB, FBWB			1	1
26	cover cap W timber		FKWB0020-004 ...	FKWB0020-012 ...	1	1
27	top hinge S	Ref. PDB, FBSL02			1	1
28	cover cap S		FKSL0010-004 ...	FKSL0010-012 ...	1	1
29	top hinge pin diam.6	FBSB0010-1 ...			1	1
30	bottom hinge	Ref. PDB, FBEL01			1	
31	bottom hinge S	Ref. PDB, FBEL02				1
32	filling piece H timber	Ref. PDB, FBFS			1	1
33	cover cap EL U		FKEU0010-004 ...	FKEU0010-012 ...	1	
34	cover cap EL-S U		FKEL0010-004 ...	FKEL0010-012 ...		1
35	bottom hinge pin diam.6	TBLB0010-1 ...			1	1
36	reb.cor.hinge	Ref. PDB, TBFE81			1	1
37	cover cap FEB rh.		TKFE7011-004 ...	TKFE7011-012 ...	1	1
	cover cap FEB lh.		TKFE7012-004 ...	TKFE7012-012 ...	1	1

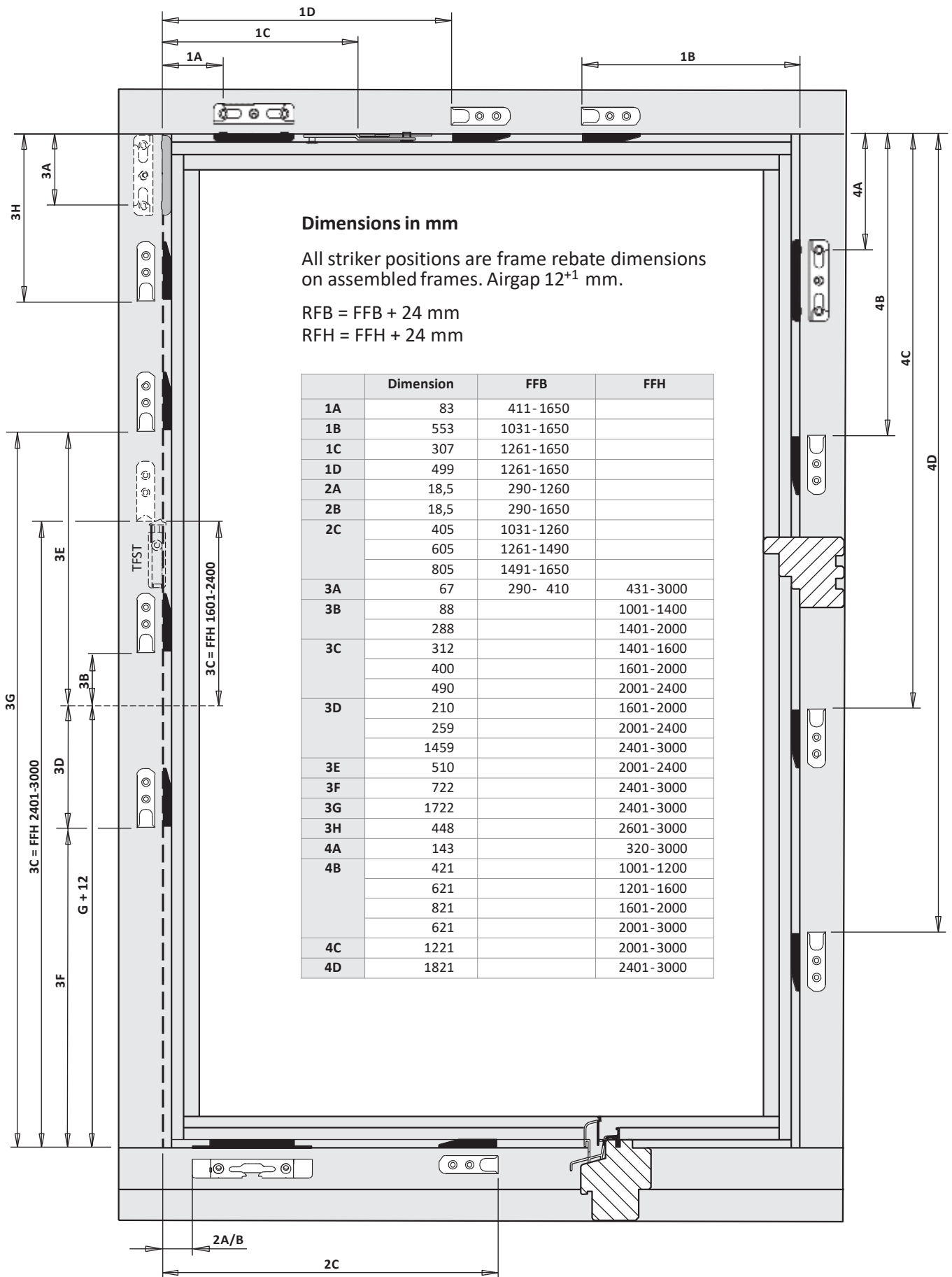

FAVORIT

Installation instructions

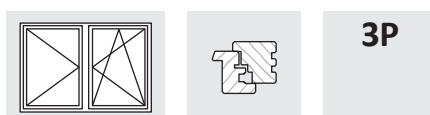

2-sash square tilt-turn turn DSG gear

timber 12 mm

3-Punkt Sicherheit

centre handle pos. (variable)

Hinge side Si-line

surface TS

backset 15 mm

6

Hardware set configuration	
General	Locking-points distance 1000
Stay side	one-piece stay
Bottom	loose sash lift
Locking side	mishandl. device on gear
Hinge side	corner drive 1S 2V
Hinge side turning points	loose filling pc I pre-mounted

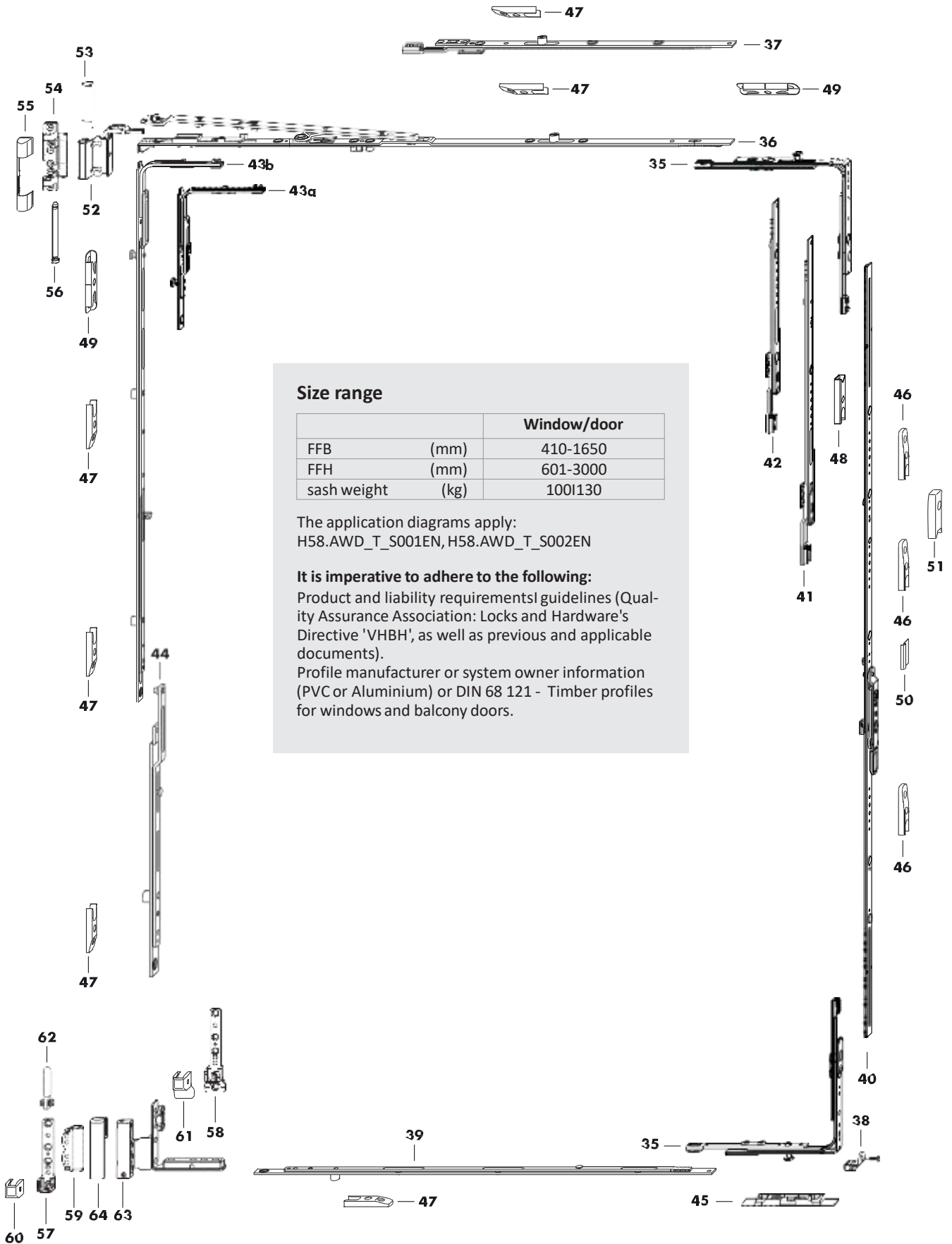
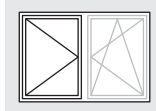

Size range

		Window/door
FFB	(mm)	410-1650
FFH	(mm)	601-3000
sash weight	(kg)	100 130

The application diagrams apply:
H58.AWD_T_S001EN, H58.AWD_T_S002EN

It is imperative to adhere to the following:

Product and liability requirements| guidelines (Quality Assurance Association: Locks and Hardware's Directive 'VHBH', as well as previous and applicable documents).

Profile manufacturer or system owner information (PVC or Aluminium) or DIN 68 121 - Timber profiles for windows and balcony doors.

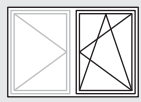

hardware layout main sash

2-sash square tilt-turn DSG gear
H12 GM Hinge side Si-line

FAVORIT

3P

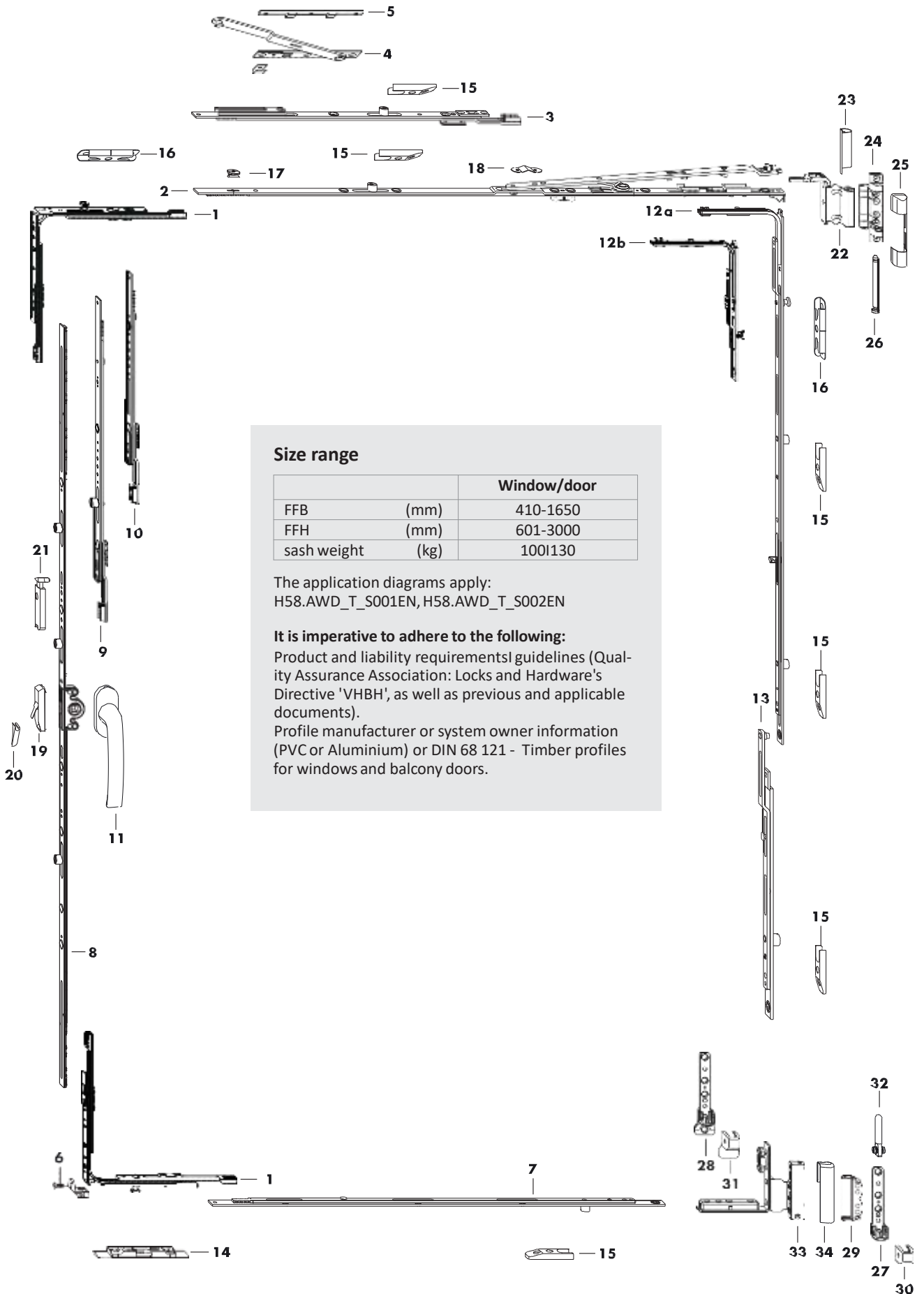

Size range

		Window/door
FFB	(mm)	410-1650
FFH	(mm)	601-3000
sash weight	(kg)	100 130

The application diagrams apply:
H58.AWD_T_S001EN, H58.AWD_T_S002EN

It is imperative to adhere to the following:

Product and liability requirements | guidelines (Quality Assurance Association: Locks and Hardware's Directive 'VHBH', as well as previous and applicable documents).

Profile manufacturer or system owner information (PVC or Aluminium) or DIN 68 121 - Timber profiles for windows and balcony doors.

List of fittings slave sash

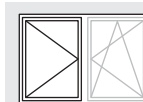
2-sash square tilt-turn/turn DSG gear
H12 GM Hinge side Si-line

Pos.	Description	Part number	QTY	FFB	FFH	Dimension G	Number of frame parts / Pos.				
						In the main sash	45	46	47	48	49
35	corn.drive FAV VS 1S ..	FEUL0510- ...	2	410- 1650			1				1
36	stay 7 sz 30	707302	1	410- 620							
	stay 7 sz 35 MV	707319		621- 800							
	stay 7 sz 50 MV	707326		801- 1030							
	stay 7 sz 55 MV	707333		1031- 1260						1	
	stay 7 sz 50 MV	707326		1261- 1490						1	
	stay 7 sz 55 MV	707333		1491- 1650						1	
37	linkage sz 460 MV	713266	1	1261- 1650					1		
38	sash lift S-ES	Ref. PDB, FMFH	1	410- 1650							
39	centre lock sz 50	700969	1	1031- 1260					1		
	centre lock sz 70	700976		1261- 1490					1		
	centre lock sz 90	700983		1491- 1650					1		
40	s.sash gear16 FAV 60I300	FGKS4030- ...	1		601- 800	300- 400					
	sec.sash gear16 FAV sz .80 1SB	FGMS4040- ...		801- 1000	400- 500						
	sec.sash gear16 FAV sz .80 1SB	FGMS4040- ...		1001- 1200	500- 600	1					
	sec.sash gear16 FAV sz 120 1SB	FGMS4050- ...		1201- 1400	600- 700	1					
	sec.sash gear16 FAV sz 120 2SB	FGMS4120- ...		1401- 1600	700- 800	1					
	sec.sash gear16 FAV sz 160 2SB	FGMS4130- ...		1601- 2000	800- 1000	1					
	sec.sash gear16 FAV sz 200 3SB	FGMS4100- ...		2001- 2400	1000- 1200	1					
	sec.sash gear16 FAV sz 200 3SB	FGMS4100- ...		2401- 3000	1200	1					
41	linkage FAV sz 200 A0767	FZSZ0120- ...	1		2401- 2600					1	
	linkage FAV sz 400 A0767	FZSZ0130- ...		2601- 3000						1	
42	linkage FAV sz 200 A0767	FZSZ0120- ...	1		2801- 3000						
43a	corn.drive BS sz 20 1S ..	FEUL2100- ...	1		601- 1000					1	
43b	corn.drive BS sz 50 1S 1V ..	FEUL2110- ...	1		1001- 1200				1	1	
	corn.drive BS sz 70 1S 1V ..	FEUL2120- ...		1201- 1600					1	1	
	corn.drive BS sz 90 1S 1V ..	FEUL2130- ...		1601- 2000					1	1	
	corn.drive BS sz 130 1S 2V ..	FEUL2140- ...		2001- 3000					2	1	
44	MV extension sz 60	700952	1		2401- 3000				1		
45	tilt lock bear. S-ES FH	Ref. PDB, FRKA									
46	striker plate f. gear MV	Ref. PDB, FRSA02									
47	striker plate 56	Ref. PDB, FRSB									
48	striker plate 56 A0767	TRSB0020- ...									
49	striker plate S-RS	Ref. PDB, TRSK									
on request											
50	stop	Ref. PDB, FRZF04	1		801- 3000						
51	striker snapper A0767	TRST0010- ...	1		1801- 3000						

Pos.	Description	Hinge side turning points				required as per sash weight	
		Part number			100 kg	130 kg	
		surface TS	RAL9016	RAL8022			
52	stay hinge	Ref. PDB, FBWB			1	1	
53	cover cap W timber		FKWB0020-004 ...	FKWB0020-012 ...	1	1	
54	top hinge S	Ref. PDB, FBLSL02			1	1	
55	cover cap S		FKSL0010-004 ...	FKSL0010-012 ...	1	1	
56	top hinge pin diam.6	FBSB0010-1 ...			1	1	
57	bottom hinge	Ref. PDB, FBEL01			1		
58	bottom hinge S	Ref. PDB, FBEL02				1	
59	filling piece H timber	Ref. PDB, FBFS			1	1	
60	cover cap EL U		FKEU0010-004 ...	FKEU0010-012 ...	1		
61	cover cap EL-S U		FKEL0010-004 ...	FKEL0010-012 ...		1	
62	bottom hinge pin diam.6	TBLB0010-1 ...			1	1	
63	reb.cor.hinge	Ref. PDB, TBFE81			1	1	
64	cover cap FEB rh.		TKFE7011-004 ...	TKFE7011-012 ...	1	1	
	cover cap FEB lh.		TKFE7012-004 ...	TKFE7012-012 ...	1	1	

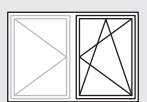

List of fittings main sash

2-sash square tilt-turn turn DSG gear
H12 GM Hinge side Si-line

FAVORIT

3P

Pos.	Description	Part number	QTY	FFB	FFH	Dimension G	Number of frame parts / Pos.		
							14	15	16
1	corn.drive FAV VS 1S ..	FEUL0510- ...	2	410- 1650			1		1
2	stay 7 sz 30	707302	1	410- 620					
	stay 7 sz 35 MV	707319		621- 800					
	stay 7 sz 50 MV	707326		801- 1030					
	stay 7 sz 55 MV	707333		1031- 1260				1	
	stay 7 sz 50 MV	707326		1261- 1490				1	
	stay 7 sz 55 MV	707333		1491- 1650				1	
3	linkage SIZ FAV 1V	FZOK0100- ...	1	1261- 1650				1	
4	additional stay	Ref. PDB, TSZS	1	1261- 1650					
5	packer Z	Ref. PDB, FRUP01	1	1261- 1650					
6	sash lift S-ES	Ref. PDB, FMFH	1	410- 1650					
7	centre lock sz 50	700969	1	1031- 1260				1	
	centre lock sz 70	700976		1261- 1490				1	
	centre lock sz 90	700983		1491- 1650				1	
8	gear 15 FAV sz 60	FGMK4020- ...	1		601- 800	300- 400			
	gear 15 FAV sz 80 1V	FGMK4040- ...			801- 1000	400- 500			
	gear 15 FAV sz 80 1V	FGMK4040- ...			1001- 1200	500- 600			
	gear 15 FAV sz 120 1V	FGMK4050- ...			1201- 1400	600- 700			
	gear 15 FAV sz 120 2V	FGMK4070- ...			1401- 1600	700- 800			
	gear 15 FAV sz 160 2V	FGMK4060- ...			1601- 2000	800- 1000			
	gear 15 FAV sz 200 3V	FGMK4110- ...			2001- 2400	1000- 1200			
	gear 15 FAV sz 200 3V	FGMK4110- ...			2401- 3000	1200			
9	linkage FAV sz 200 A0767	FZSZ0120- ...	1		2401- 2600				
	linkage FAV sz 400 1V	FZSZ0110- ...			2601- 3000				
10	linkage FAV sz 200 A0767	FZSZ0120- ...	1		2801- 3000				
11	handle Globe	Ref.access. ZHGS	1		601- 3000				
12a	corn.drive BS sz 20 1S ..	FEUL2100- ...	1		601- 1000			1	
12b	corn.drive BS sz 50 1S 1V ..	FEUL2110- ...	1		1001- 1200		1	1	
	corn.drive BS sz 70 1S 1V ..	FEUL2120- ...			1201- 1600		1	1	
	corn.drive BS sz 90 1S 1V ..	FEUL2130- ...			1601- 2000		1	1	
	corn.drive BS sz 130 1S 2V ..	FEUL2140- ...			2001- 3000		2	1	
13	MV extension sz 60	700952	1		2401- 3000		1		
14	tilt lock bear. S-ES FH	Ref. PDB, FRKA							
15	striker plate 56	Ref. PDB, FRSB							
16	striker plate S-RS	Ref. PDB, TRSK							
on request									
17	location piece ..	702543	1						
18	tilt restrictor ..	805701	1		601- 800				
19	mishandling device FAV.	FFBS0110- ...	1		801- 3000				
20	pressure piece	Ref. PDB, TFFD	1		801- 3000				
21	snapper switchable rh.	TFST0011- ...	1		1601- 3000				
	snapper switchable lh.	TFST0012- ...			1601- 3000				

Pos.	Description	Hinge side turning points				required as per sash weight	
		Part number			100 kg	130 kg	
		surface TS	RAL9016	RAL8022			
22	stay hinge	Ref. PDB, FBWB			1	1	
23	cover cap W timber		FKWB0020-004 ...	FKWB0020-012 ...	1	1	
24	top hinge S	Ref. PDB, FBLS02			1	1	
25	cover cap S		FKSL0010-004 ...	FKSL0010-012 ...	1	1	
26	top hinge pin diam.6	FBSB0010-1 ...			1	1	
27	bottom hinge	Ref. PDB, FBEL01			1		
28	bottom hinge S	Ref. PDB, FBEL02				1	
29	filling piece H timber	Ref. PDB, FBFS			1	1	
30	cover cap EL U		FKEU0010-004 ...	FKEU0010-012 ...	1		
31	cover cap EL-S U		FKEL0010-004 ...	FKEL0010-012 ...		1	
32	bottom hinge pin diam.6	TBLB0010-1 ...			1	1	
33	reb.cor.hinge	Ref. PDB, TBFE81			1	1	
34	cover cap FEB rh.		TKFE7011-004 ...	TKFE7011-012 ...	1	1	
	cover cap FEB lh.		TKFE7012-004 ...	TKFE7012-012 ...	1	1	

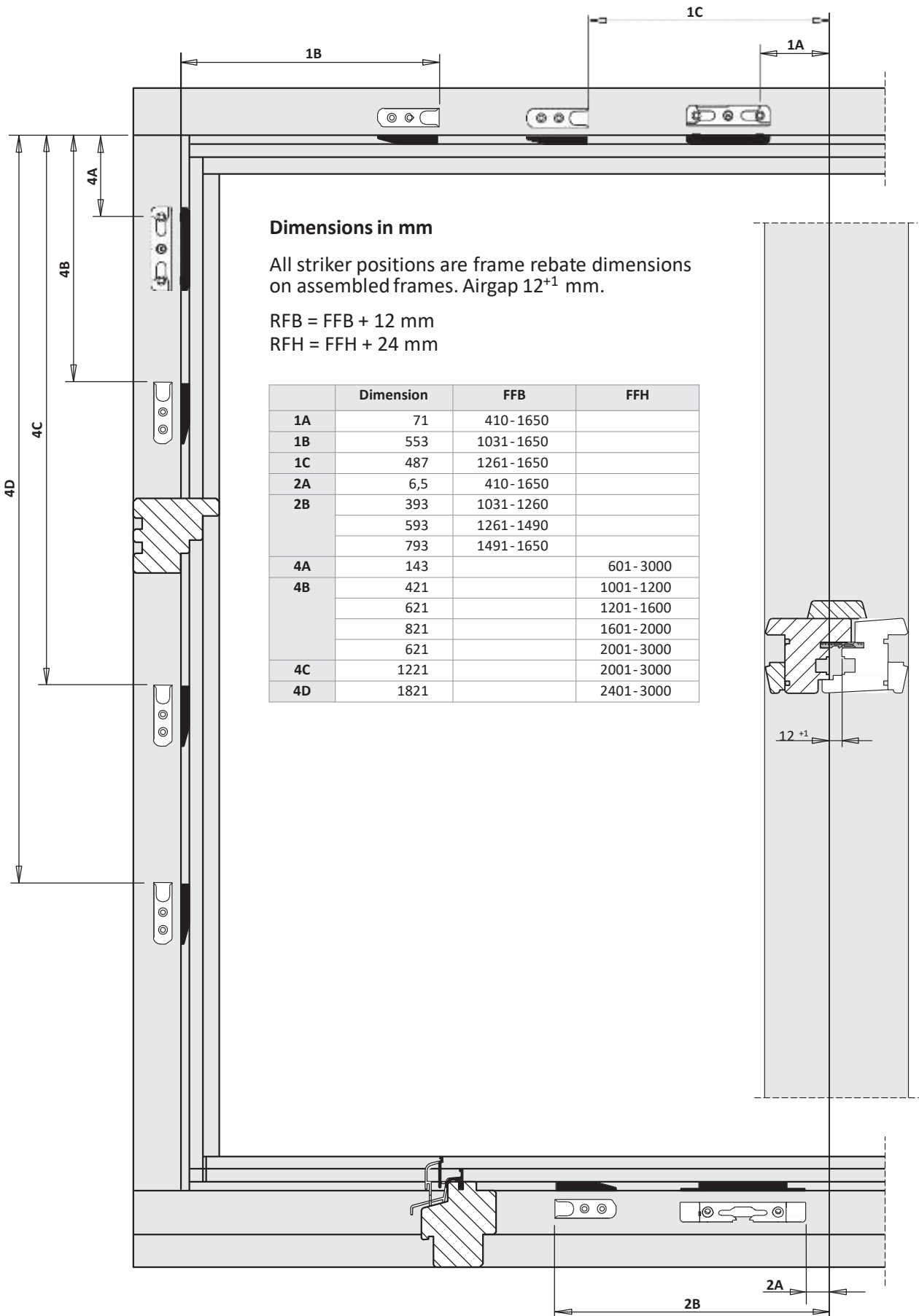
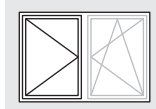

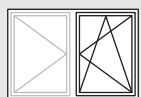

Frame dimensions main sash
2-sash square tilt-turn DSG gear
H12 GM Hinge side Si-line

FAVORIT

3P

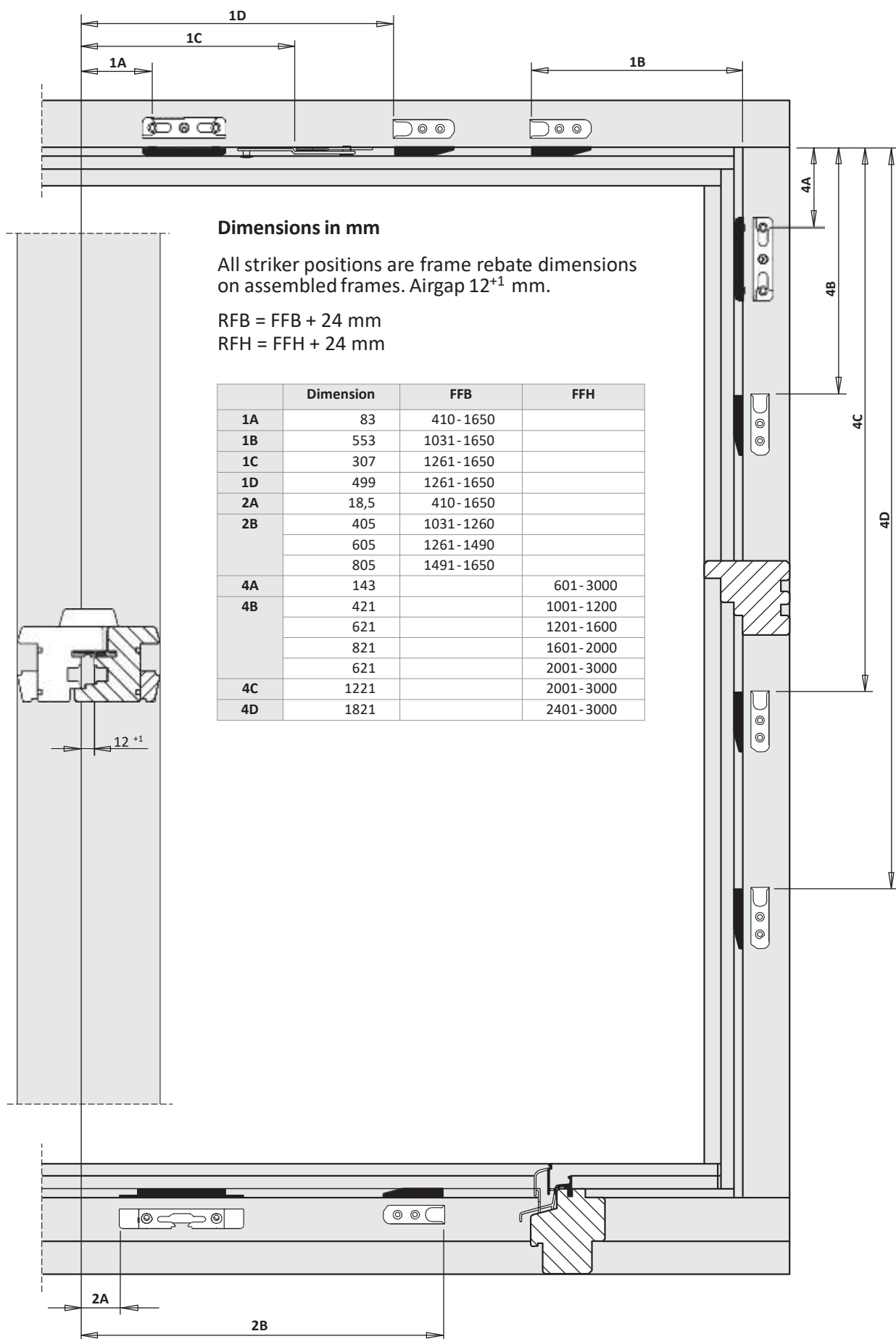

6

FAVORIT

Installation instructions



1-sash square tilt before turn (TBT)

timber 12 mm

3-Punkt Sicherheit

centre handle pos. (variable)

Hinge side Si-line

surface TS

backset 15 mm

6

Hardware set configuration	
General	Locking-points distance 1000
Stay side	one-piece stay
Bottom	loose sash lift
Locking side	mishandl. device on gear
Hinge side	corner drive 1S 2V
Hinge side turning points	loose filling pc I pre-mounted

hardware layout

1-sash square tilt before turn (TBT)

H12 GM Hinge side Si-line



6

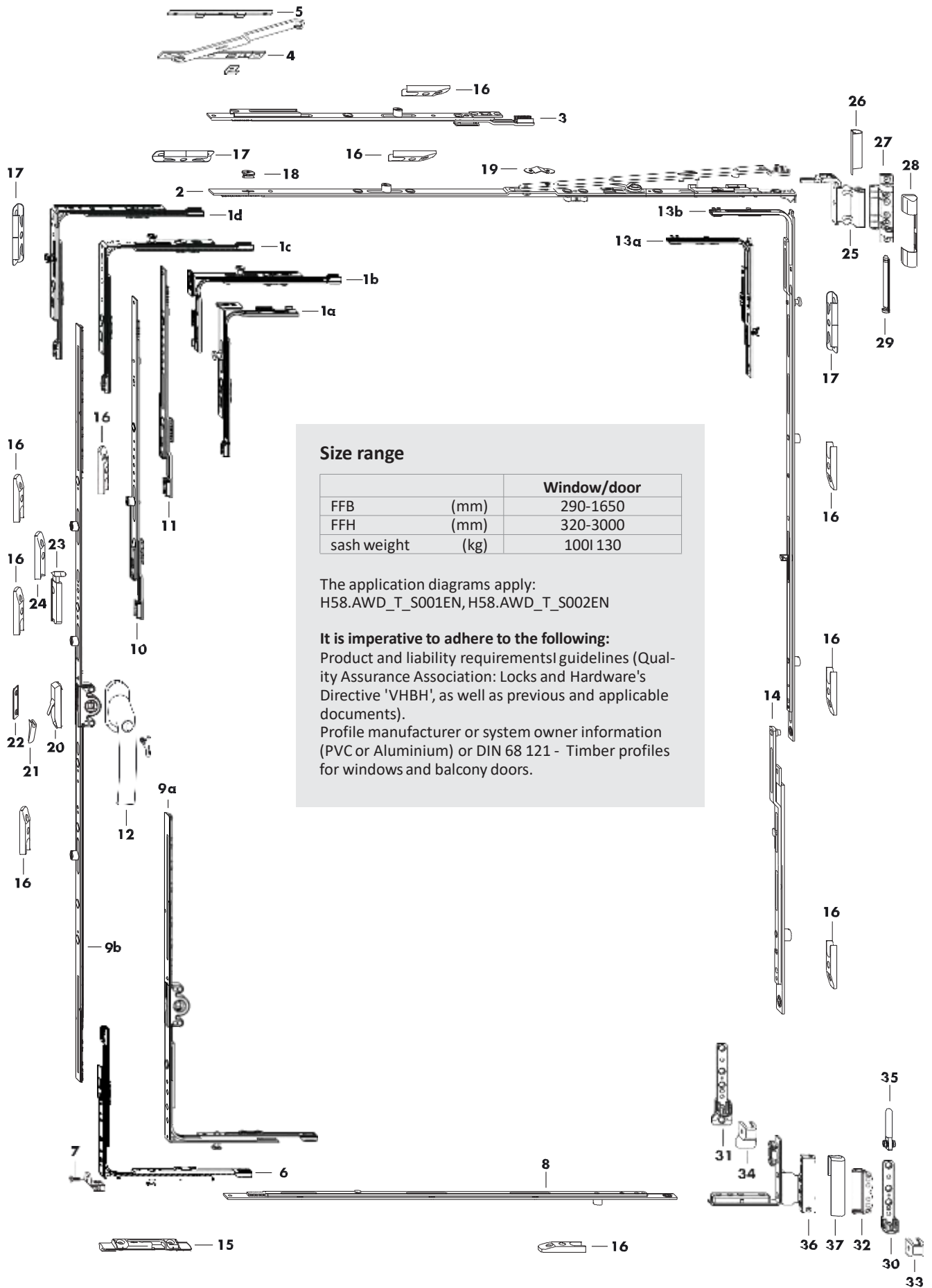

Size range

		Window/door
FFB	(mm)	290-1650
FFH	(mm)	320-3000
sash weight	(kg)	100 130

The application diagrams apply:
H58.AWD_T_S001EN, H58.AWD_T_S002EN

It is imperative to adhere to the following:
Product and liability requirements| guidelines (Quality Assurance Association: Locks and Hardware's Directive 'VHBH', as well as previous and applicable documents).
Profile manufacturer or system owner information (PVC or Aluminium) or DIN 68 121 - Timber profiles for windows and balcony doors.



List of fittings
1-sash square tilt before turn (TBT)
H12 GM Hinge side Si-line

FAVORIT

3P

Pos.	Description	Part number	QTY	FFB	FFH	Dimension G	Number of frame parts / Pos.		
							15	16	17
1a	corn.drive FAV VSO narrow 1S ..	FEUL0530- ...	1	290- 410	431-3000				1
1b	corn.drive FAV VSO narrow 1S ..	FEUL0530- ...	1	411- 800	320- 430				1
1c	corn.drive FAV VS 1S ..	FEUL0510- ...	1	411- 1260	431-3000				1
1d	corn.drive FAV VS 1S ..	FEUL0510- ...	1	1261- 1650	431-3000				1
2	stay 7 TBT sz 30	707357	1	290- 620					
	stay 7 TBT sz 35 MV	707364		621- 800					
	stay 7 TBT sz 50 MV	707371		801- 1030					
	stay 7 TBT sz 55 MV	707388		1031- 1260				1	
	stay 7 TBT sz 50 MV	707371		1261- 1490				1	
	stay 7 TBT sz 55 MV	707388		1491- 1650				1	
3	linkage SIZ TBT FAV 1V	FZOT0100- ...	1	1261- 1650				1	
4	additional stay	Ref. PDB, TSZS	1	1261- 1650					
5	packer Z	Ref. PDB, FRUP01	1	1261- 1650					
6	corn.drive FAV VS 1S ..	FEUL0510- ...	1	290- 1650	601-3000		1		
7	sash lift S-ES	Ref. PDB, FMFH	1	290- 1650					
8	centre lock sz 50	700969	1	1031- 1260				1	
	centre lock sz 70	700976		1261- 1490				1	
	centre lock sz 90	700983		1491- 1650				1	
9a	gear 15 FAV sz 30IG180 S-ES	FGKK4020- ...	1	411- 800	320- 430	180	1		
	gear 15 FAV sz 30IG180 S-ES	FGKK4020- ...		431- 600	180	1			
9b	gear 15 FAV sz 60	FGMK4020- ...	1		601- 800	300- 400			
	gear 15 FAV sz 80 1V	FGMK4040- ...		801- 1000	400- 500				
	gear 15 FAV sz 80 1V	FGMK4040- ...		1001- 1200	500- 600		1		
	gear 15 FAV sz 120 1V	FGMK4050- ...		1201- 1400	600- 700		1		
	gear 15 FAV sz 120 2V	FGMK4070- ...		1401- 1600	700- 800		2		
	gear 15 FAV sz 160 2V	FGMK4060- ...		1601- 2000	800- 1000		2		
	gear 15 FAV sz 200 3V	FGMK4110- ...		2001- 2400	1000- 1200		2		
	gear 15 FAV sz 200 3V	FGMK4110- ...		2401- 3000	1200		2		
10	linkage FAV sz 200 A0767	FZSZ0120- ...	1		2401- 2600				
	linkage FAV sz 400 1V	FZSZ0110- ...		2601- 3000			1		
11	linkage FAV sz 200 A0767	FZSZ0120- ...	1		2801- 3000				
12	handle Globe TBT lockable	Ref.access. ZHGT	1		320- 3000				
13a	corn.drive BS sz 20 1S ..	FEUL2100- ...	1		320- 1000				1
13b	corn.drive BS sz 50 1S 1V ..	FEUL2110- ...	1		1001- 1200			1	1
	corn.drive BS sz 70 1S 1V ..	FEUL2120- ...		1201- 1600			1	1	
	corn.drive BS sz 90 1S 1V ..	FEUL2130- ...		1601- 2000			1	1	
	corn.drive BS sz 130 1S 2V ..	FEUL2140- ...		2001- 3000			2	1	
14	MV extension sz 60	700952	1		2401- 3000			1	
15	tilt lock bear. S-ES FH TBT	Ref. PDB, FRKB							
16	striker plate 56	Ref. PDB, FRSB							
17	striker plate S-RS	Ref. PDB, TRSK							
on request									
18	location piece ..	702543	1						
19	tilt restrictor ..	805701	1		320- 800				
20	mishandling device FAV.	FFBS0110- ...	1						
21	pressure piece	Ref. PDB, TFFD	1						
22	stop	Ref. PDB, FRZF01	1						
23	snapper switchable rh.	TFST0011- ...	1		1601- 3000				
	snapper switchable lh.	TFST0012- ...		1601- 3000					
24	frame part snapper	Ref. PDB, TRST	1		1601- 3000				

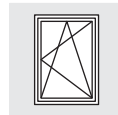

Pos.	Description	Hinge side turning points			required as per sash weight	
		surface TS	Part number		100 kg	130 kg
			RAL9016	RAL8022		
25	stay hinge	Ref. PDB, FBWB			1	1
26	cover cap W timber		FKWB0020-004 ...	FKWB0020-012 ...	1	1
27	top hinge S	Ref. PDB, FBSL02			1	1
28	cover cap S		FKSL0010-004 ...	FKSL0010-012 ...	1	1
29	top hinge pin diam.6	FBSB0010-1 ...			1	1
30	bottom hinge	Ref. PDB, FBEL01			1	
31	bottom hinge S	Ref. PDB, FBEL02				1
32	filling piece H timber	Ref. PDB, FBFS			1	1
33	cover cap EL U		FKEU0010-004 ...	FKEU0010-012 ...	1	
34	cover cap EL-S U		FKEL0010-004 ...	FKEL0010-012 ...		1
35	bottom hinge pin diam.6	TBLB0010-1 ...			1	1
36	reb.cor.hinge	Ref. PDB, TBFE81			1	1
37	cover cap FEB rh.		TKFE7011-004 ...	TKFE7011-012 ...	1	1
	cover cap FEB lh.		TKFE7012-004 ...	TKFE7012-012 ...	1	1



Frame dimensions

1-sash square tilt before turn (TBT)
H12 GM Hinge side Si-line

FAVORIT

3P

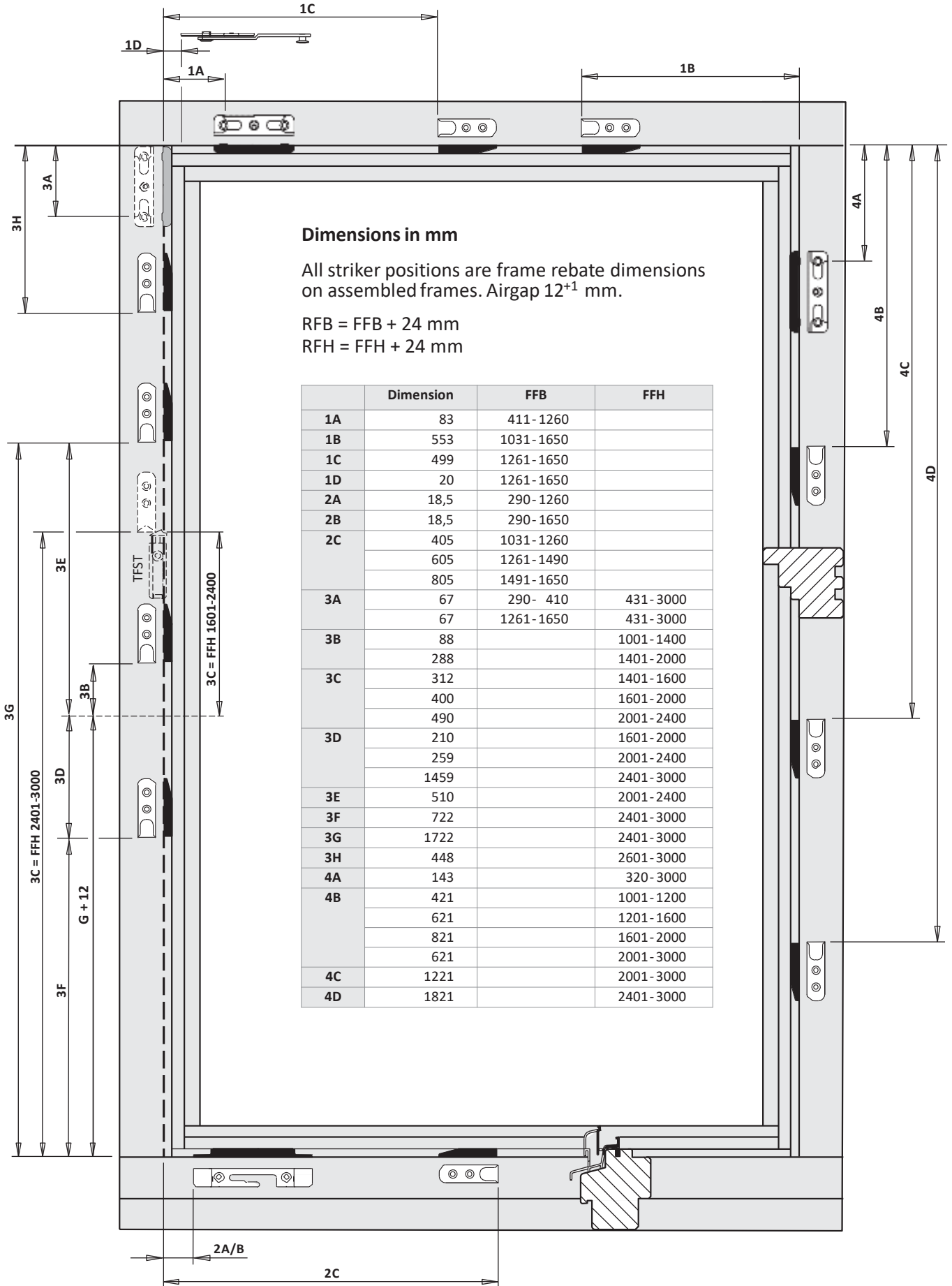

FAVORIT

Installation instructions



1-sash square turn

timber 12 mm

basic security

centre handle pos. (variable)

Hinge side Si-line

surface TS

backset 15 mm

6

Hardware set configuration

Hardware set configuration	
General	Locking-points distance 1000
Stay side	one-piece stay
Bottom	loose sash lift
Locking side	mishandl. device on gear
Hinge side turning points	loose filling pc I pre-mounted

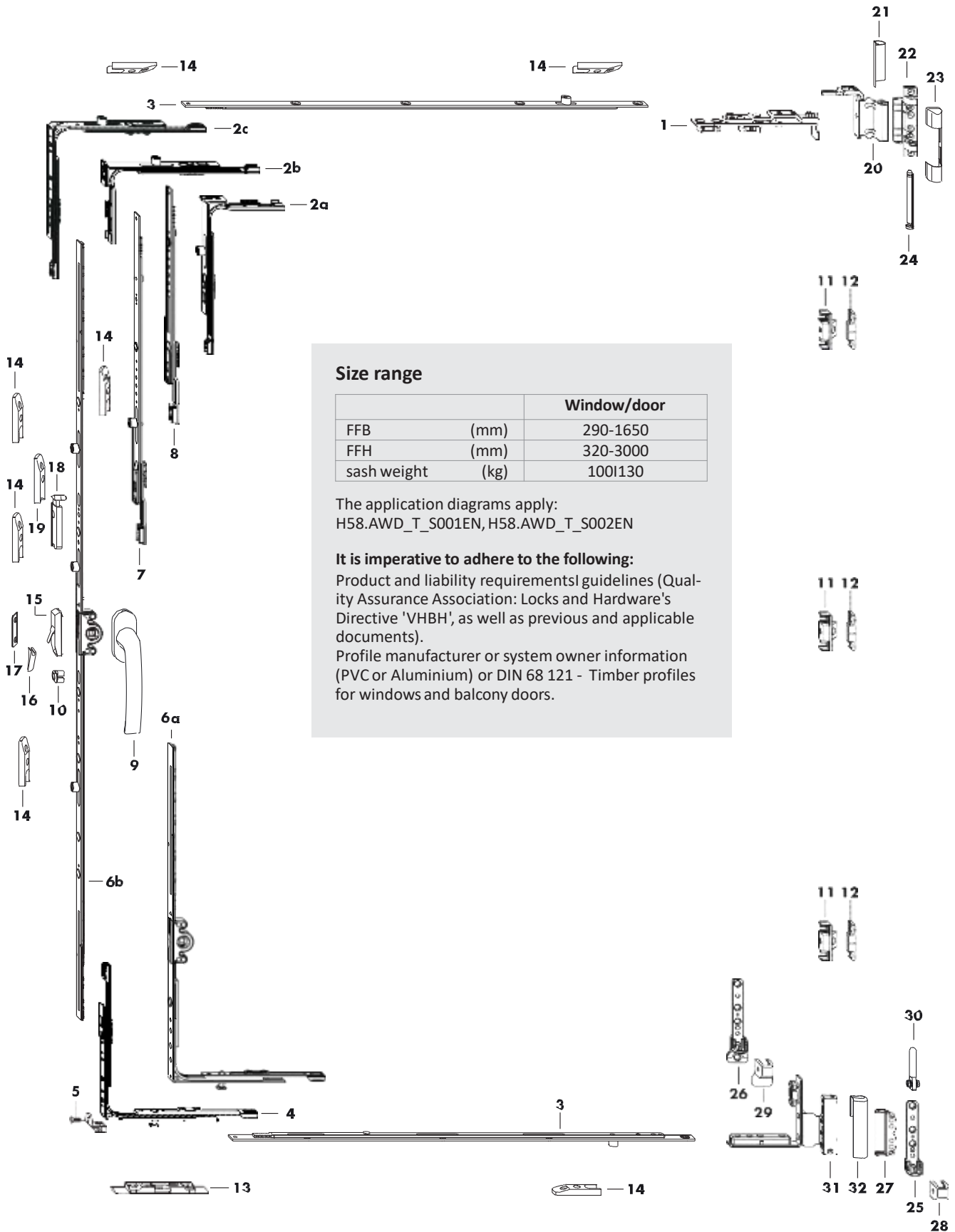
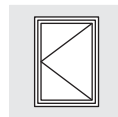

Size range

		Window/door
FFB	(mm)	290-1650
FFH	(mm)	320-3000
sash weight	(kg)	100 130

The application diagrams apply:
H58.AWD_T_S001EN, H58.AWD_T_S002EN

It is imperative to adhere to the following:

Product and liability requirements| guidelines (Quality Assurance Association: Locks and Hardware's Directive 'VHBH', as well as previous and applicable documents).

Profile manufacturer or system owner information (PVC or Aluminium) or DIN 68 121 - Timber profiles for windows and balcony doors.

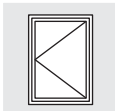

List of fittings
1-sash square turn
H12 GM Hinge side Si-line

FAVORIT

GS

Pos.	Description	Part number	QTY	FFB	FFH	Dimension G	Number of frame parts / Pos.	
							13	14
1	stay 7 DF	707340	1	290- 1650				
2a	corn.drive narrow VSO ..	FEUL0520- ...	1	290- 410	431- 3000			1
2b	corn.drive narrow VSO ..	FEUL0520- ...	1	411- 800	320- 430			1
2c	corn.drive VSO ..	FEUL0230- ...	1	411- 1650	431- 3000			1
3	centre lock sz 50	700969	2	1031- 1260				2
	centre lock sz 70	700976		1261- 1490				2
	centre lock sz 90	700983		1491- 1650				2
4	corn.drive FAV VS 1S ..	FEUL0510- ...	1	290- 1650	601- 3000		1	
5	sash lift S-ES	Ref. PDB, FMFH	1	290- 1650				
6a	gear 15 FAV sz 30IG180 S-ES	FGKK4020- ...	1	411- 800	320- 430	180	1	
	gear 15 FAV sz 30IG180 S-ES	FGKK4020- ...		290- 1260	431- 600	180	1	
6b	gear 15 FAV sz 60	FGMK4020- ...	1		601- 800	300- 400		
	gear 15 FAV sz 80 1V	FGMK4040- ...			801- 1000	400- 500		
	gear 15 FAV sz 80 1V	FGMK4040- ...			1001- 1200	500- 600		1
	gear 15 FAV sz 120 1V	FGMK4050- ...			1201- 1400	600- 700		1
	gear 15 FAV sz 120 2V	FGMK4070- ...			1401- 1600	700- 800		2
	gear 15 FAV sz 160 2V	FGMK4060- ...			1601- 2000	800- 1000		2
	gear 15 FAV sz 200 3V	FGMK4110- ...			2001- 2400	1000- 1200		2
	gear 15 FAV sz 200 3V	FGMK4110- ...			2401- 3000	1200		2
7	linkage FAV sz 200 A0767	FZSZ0120- ...	1		2401- 2600			
	linkage FAV sz 400 1V	FZSZ0110- ...			2601- 3000			1
8	linkage FAV sz 200 A0767	FZSZ0120- ...	1		2601- 3000			
9	handle Globe	Ref.access. ZHGS	1		320- 3000			
10	travel restrictor	TFHB0010- ...	1		320- 3000			
11	sash part MV	Ref. PDB, ZFMV01	1		1001- 1600			
	sash part MV	Ref. PDB, ZFMV01	2		1601- 2400			
	sash part MV	Ref. PDB, ZFMV01	3		2401- 3000			
12	frame part MV	Ref. PDB, ZRZM01	1		1001- 1600			
	frame part MV	Ref. PDB, ZRZM01	2		1601- 2400			
	frame part MV	Ref. PDB, ZRZM01	3		2401- 3000			
13	tilt lock bear. S-ES FH	Ref. PDB, FRKA						
14	striker plate 56	Ref. PDB, FRSB						
on request								
15	mishandling device FAV.	FFBS0110- ...	1					
16	pressure piece	Ref. PDB, TFFD	1					
17	stop	Ref. PDB, FRZF01	1					
18	snapper switchable rh.	TFST0011- ...	1		1601- 3000			
	snapper switchable lh.	TFST0012- ...			1601- 3000			
19	frame part snapper	Ref. PDB, TRST	1		1601- 3000			

Pos.	Description	Hinge side turning points				required as per sash weight	
		Part number			100 kg	130 kg	
		surface TS	RAL9016	RAL8022			
20	stay hinge	Ref. PDB, FBWB			1	1	
21	cover cap W timber		FKWB0020-004 ...	FKWB0020-012 ...	1	1	
22	top hinge S	Ref. PDB, FBSL02			1	1	
23	cover cap S		FKSL0010-004 ...	FKSL0010-012 ...	1	1	
24	top hinge pin diam.6	FBSB0010-1 ...			1	1	
25	bottom hinge	Ref. PDB, FBEL01			1		
26	bottom hinge S	Ref. PDB, FBEL02				1	
27	filling piece H timber	Ref. PDB, FBFS			1	1	
28	cover cap EL U		FKEU0010-004 ...	FKEU0010-012 ...	1		
29	cover cap EL-S U		FKEL0010-004 ...	FKEL0010-012 ...		1	
30	bottom hinge pin diam.6	TBLB0010-1 ...			1	1	
31	reb.cor.hinge	Ref. PDB, TBFE81			1	1	
32	cover cap FEB rh.		TKFE7011-004 ...	TKFE7011-012 ...	1	1	
	cover cap FEB lh.		TKFE7012-004 ...	TKFE7012-012 ...	1	1	

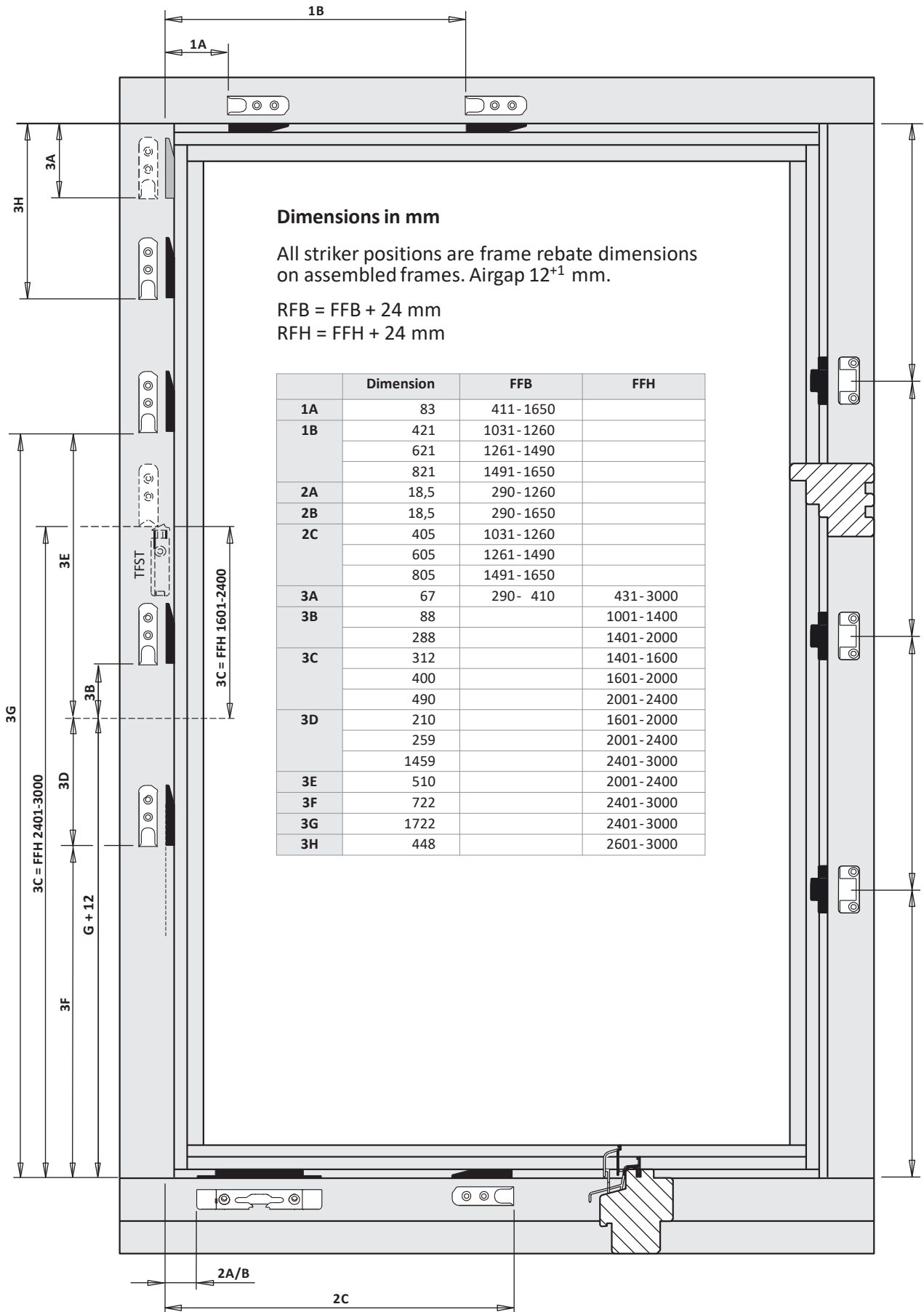
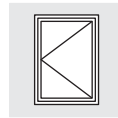

FAVORIT

Installation instructions



1-sash square turn

timber 12 mm

basic security

centre handle pos. (variable)

Hinge side Si-line

surface TS

backset 15 mm

6

Hardware set configuration	
General	Locking-points distance 1000; gear DF
Stay side	one-piece stay
Locking side	mishandl. device on gear
Hinge side turning points	loose filling pc I pre-mounted

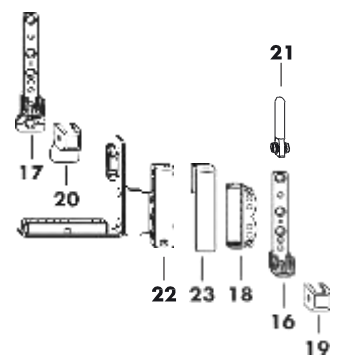
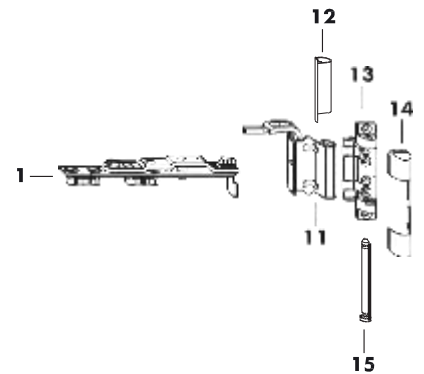
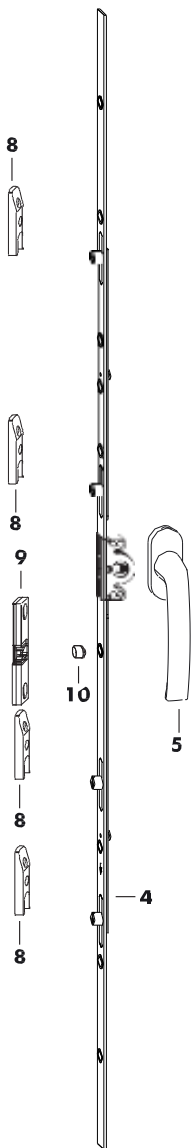
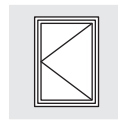

Size range

		Window/door
FFB	(mm)	290-800
FFH	(mm)	320-2400
sash weight	(kg)	100 130

The application diagrams apply:
H58.AWD_T_S001EN, H58.AWD_T_S002EN

It is imperative to adhere to the following:

Product and liability requirementsI guidelines (Quality Assurance Association: Locks and Hardware's Directive 'VHBH', as well as previous and applicable documents).

Profile manufacturer or system owner information (PVC or Aluminium) or DIN 68 121 - Timber profiles for windows and balcony doors.

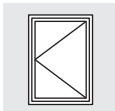

List of fittings
1-sash square turn
H12 GM Hinge side Si-line

FAVORIT

GS

Pos.	Description	Part number	QTY	FFB	FFH	Dimension G	Number of frame parts /
							Pos.
							8
1	stay 7 DF	707340	1	290- 800			
2	sash lift .. A2000	TFFH0010- ...	1	290- 800			
3	run-up FHITiP	Ref. PDB, TRAL	1	290- 800			
4	gear 15 FAVIDF sz 20 1V	FGMD4010- ...	1		320- 430	180	1
	gear 15 FAVIDF sz 40 2V	FGMD4020- ...		431- 600	180	2	
	gear 15 FAVIDF sz 60 2V	FGMD4030- ...		601- 800	300- 400	2	
	gear 15 FAVIDF sz 80 2V	FGMD4040- ...		801-1000	400- 500	2	
	gear 15 FAVIDF sz 100 3V	FGMD4050- ...		1001-1200	500- 600	3	
	gear 15 FAVIDF sz 120 3V	FGMD4060- ...		1201-1400	600- 700	3	
	gear 15 FAVIDF sz 140 3V	FGMD4070- ...		1401-1600	700- 800	3	
	gear 15 FAVIDF sz 160 4V	FGMD4080- ...		1601-1800	800- 900	4	
	gear 15 FAVIDF sz 180 4V	FGMD4090- ...		1801-2000	900-1000	4	
	gear 15 FAVIDF sz 200 4V	FGMD4100- ...		2001-2200	1000-1100	4	
gear 15 FAVIDF sz 220 4V	FGMD4110- ...	2201-2400	1100-1200	4			
5	handle Globe	Ref.access. ZHGS	1		320-2400		
6	sash part MV	Ref. PDB, ZFMV01	1		1001-1600		
	sash part MV	Ref. PDB, ZFMV01	2		1601-2400		
7	frame part MV	Ref. PDB, ZRZM01	1		1001-1600		
	frame part MV	Ref. PDB, ZRZM01	2		1601-2400		
8	striker plate 56	Ref. PDB, FRSB					
on request							
9	snapper	Ref. PDB, FRZB	1		1801-2400		
10	sleeve	Ref. PDB, FFHU	1		1801-2400		

6

Hinge side turning points						
Pos.	Description	Part number			required as per sash weight	
		surface TS	RAL9016	RAL8022	100 kg	130 kg
11	stay hinge	Ref. PDB, FBWB			1	1
12	cover cap W timber		FKWB0020-004 ...	FKWB0020-012 ...	1	1
13	top hinge S	Ref. PDB, FBLSL02			1	1
14	cover cap S		FKSL0010-004 ...	FKSL0010-012 ...	1	1
15	top hinge pin diam.6	FBSB0010-1 ...			1	1
16	bottom hinge	Ref. PDB, FBEL01			1	
17	bottom hinge S	Ref. PDB, FBEL02				1
18	filling piece H timber	Ref. PDB, FBFS			1	1
19	cover cap EL U		FKEU0010-004 ...	FKEU0010-012 ...	1	
20	cover cap EL-S U		FKEL0010-004 ...	FKEL0010-012 ...		1
21	bottom hinge pin diam.6	TBLB0010-1 ...			1	1
22	reb.cor.hinge	Ref. PDB, TBFE81			1	1
23	cover cap FEB rh.		TKFE7011-004 ...	TKFE7011-012 ...	1	1
	cover cap FEB lh.		TKFE7012-004 ...	TKFE7012-012 ...	1	1

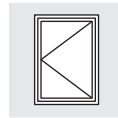

6

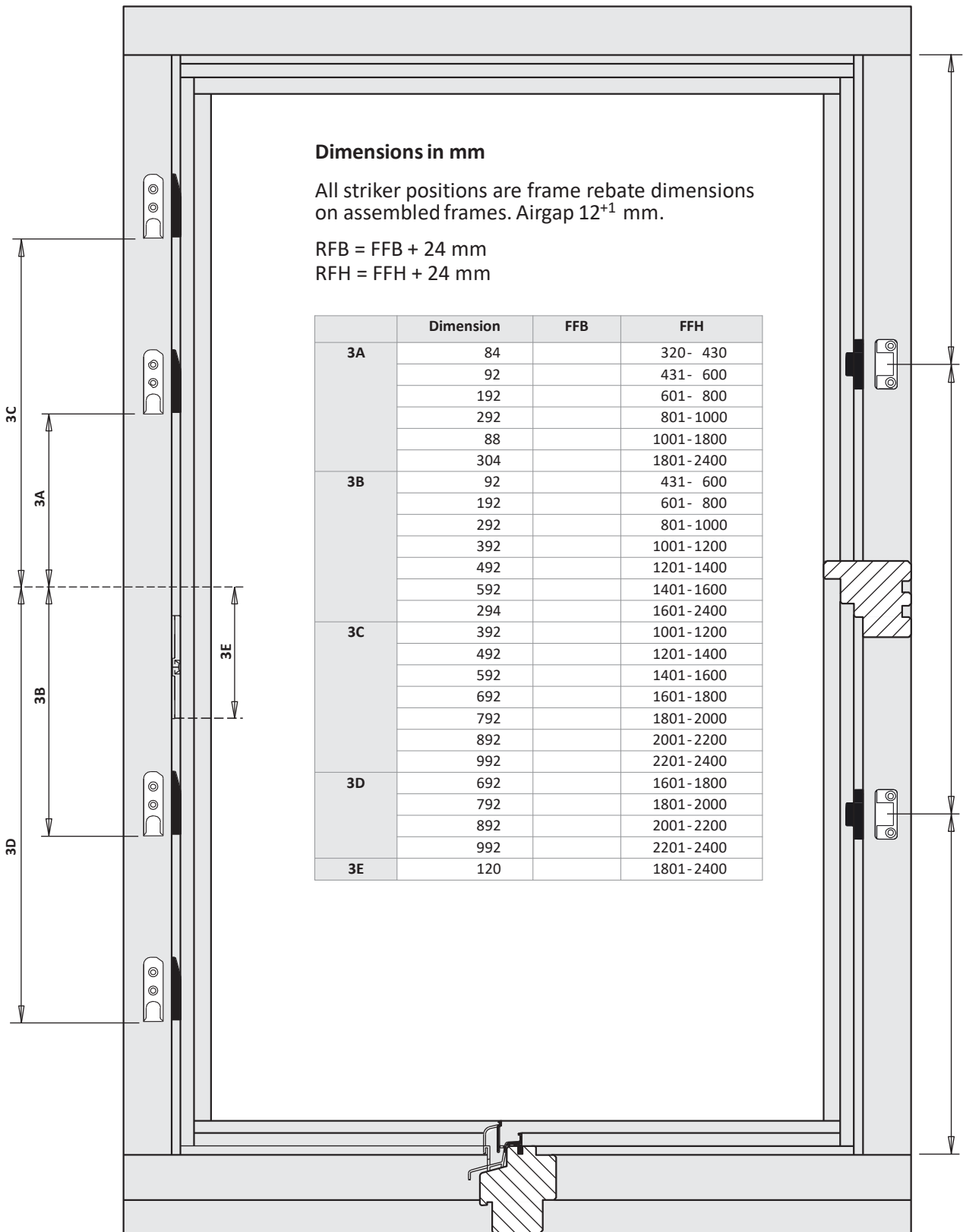

FAVORIT

Installation instructions



1-sash square tilt

timber 12 mm

basic security

centre handle pos. (variable)

hinge side Si-line

surface TS

backset 15 mm

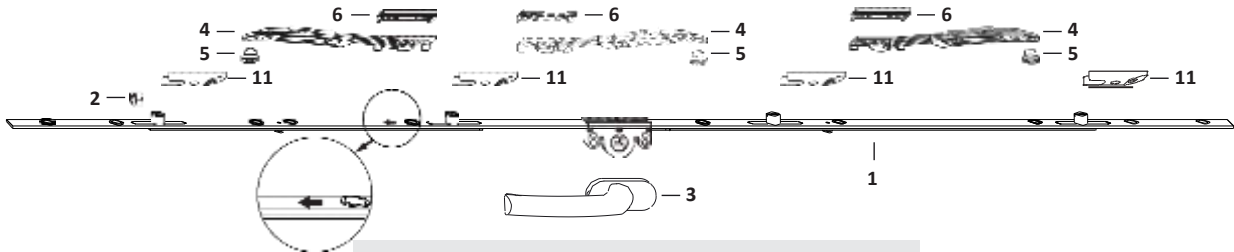
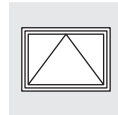

Size range

		Window
FFB	(mm)	528 – 2400
FFH	(mm)	350 – 800
sash weight	(kg)	50

Please strictly adhere to the following application diagram: H58.AWD_T_S030EN

It is imperative to adhere to the following:
Product and liability requirements/guidelines (Quality Assurance Association: Locks and Hardware's Directive 'VHBH', as well as previous and applicable documents).

Profile manufacturer or system owner information (PVC or Aluminium) or DIN 68 121 - Timber profiles or windows and balcony doors.

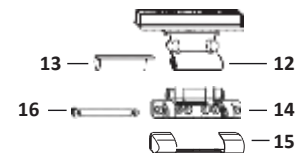
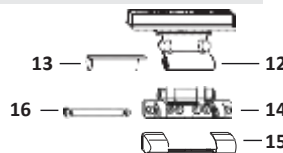
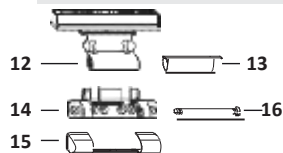
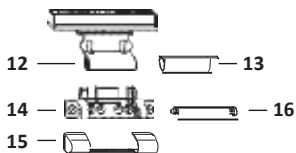

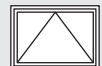

List of fittings
1-sash square tilt
H12 GM hinge side Si-line

FAVORIT

GS

Pos.	Description	Part number	QTY	FFB	FFH	Dimension G	Number of frame parts Pos. 11
1	gear 15 FAV/DF sz 40 2V	FGMD4020-...	1	528 – 600		215 – 300	2
	gear 15 FAV/DF sz 60 2V	FGMD4030-...		601 – 800		300 – 400	2
	gear 15 FAV/DF sz 80 2V	FGMD4040-...		801 – 1000		400 – 500	2
	gear 15 FAV/DF sz 100 3V	FGMD4050-...		1001 – 1200		500 – 600	3
	gear 15 FAV/DF sz 120 3V	FGMD4060-...		1201 – 1400		600 – 700	3
	gear 15 FAV/DF sz 140 3V	FGMD4070-...		1401 – 1600		700 – 800	3
	gear 15 FAV/DF sz 160 4V	FGMD4080-...		1601 – 1800		800 – 900	3
	gear 15 FAV/DF sz 180 4V	FGMD4090-...		1801 – 2000		900 – 1000	3
	gear 15 FAV/DF sz 200 4V	FGMD4100-...		2001 – 2200		1000 – 1100	4
gear 15 FAV/DF sz 220 4V	FGMD4110-...	2201 – 2400	1100 – 1200	4			
2	travel restrictor	TFHB0010-...	1	528 – 2400			
3	handle GLOBE	Ref.access., ZHGS	1	528 – 2400			
4	telescopic tilt only stay	TSKF0020-...	1	528 – 1000			
			2	1001 – 2400			
5	lock.bolt f.rais.ring facepl.	TFZB0050-...	1	528 – 1000			
			2	1001 – 2400			
6	packer RB/FPS A....	s. PDB, FRUP02	1	528 – 1000			
			2	1001 – 2400			
7	tilt only safety stay 25 sz.1 rh	ASFP0031-...	1		350 – 500		
	tilt only safety stay 25 sz.2 rh	ASFP0041-...			501 – 800		
8	tilt only safety stay 25 sz.1 lh	ASFP0032-...	1		350 – 500		
	tilt only safety stay 25 sz.2 lh	ASFP0042-...			501 – 800		
9	fixing claw UGRP	ZFFP0010-...	2		350 – 800		
10	packer RB/FPS A....	Ref. PDB, FRUP02	2		350 – 800		
11	striker plate 56 A....	Ref. PDB, FRSB					

Hinge side turning points

Pos.	Description	surface TS	Part number			QTY - FFB		
			RAL9016	RAL8022		528 – 800	801 – 1800	1801 – 2400
12	tilt sash hinge H	Ref. PDB, FBKF				2	3	4
13	cover cap W H		FKWB0020- 004...	FKWB0020- 012...		2	3	4
14	Scherenlager DH H	Ref. PDB, FBLS01				2	3	4
15	cover cap S		FKSL0010- 004...	FKSL0010- 012...		2	3	4
16	top hinge pin \26	FBSB0010- 1...				2	3	4

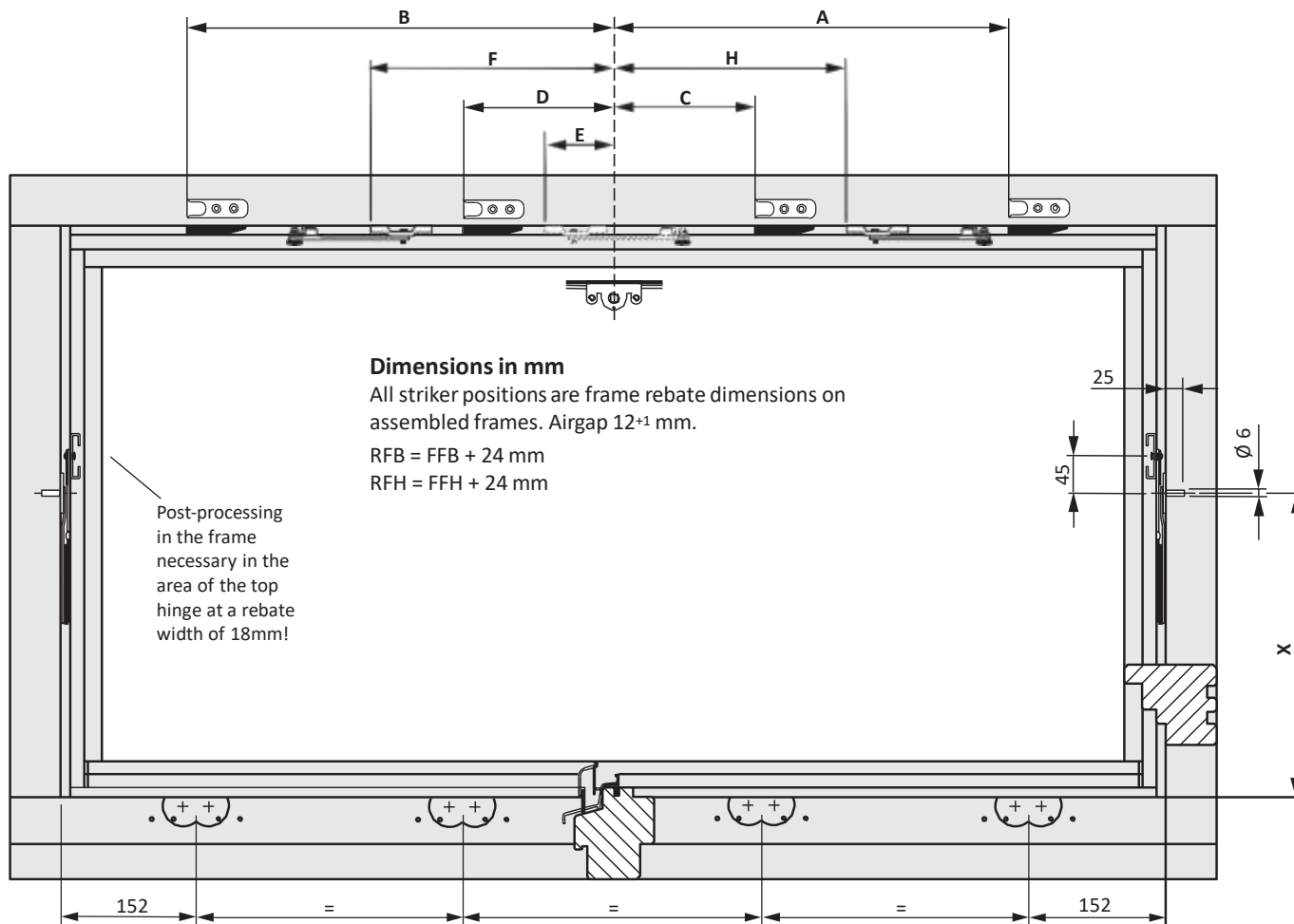
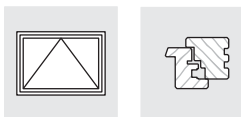

	Dimension	FFB
A	93	528 – 600
	193	601 – 800
	293	801 – 1000
	393	1001 – 1200
	493	1201 – 1400
	593	1401 – 1600
	693	1601 – 1800
	793	1801 – 2000
	893	2001 – 2200
	993	2201 – 2400
B	91	528 – 600
	191	601 – 800
	291	801 – 1000
	391	1001 – 1200
	491	1201 – 1400
	591	1401 – 1600
	691	1601 – 1800
	791	1801 – 2000
	891	2001 – 2200
	991	2201 – 2400
C	88	1001 – 2000
	305	2001 – 2400
D	291	2001 – 2400

	Dimension	FFB	FFH
E	264	528 – 600	
	0	601 – 800	
	202	801 – 1000	
F	172	1001 – 1200	
	235	1201 – 1400	
	424	1401 – 1600	
	424	1601 – 1800	
	571	1801 – 2000	
	654	2001 – 2200	
	707	2201 – 2400	
H	191	1001 – 1400	
	389	1401 – 1600	
	492	1601 – 1800	
	440	1801 – 2000	
	590	2001 – 2200	
	689	2201 – 2400	
X	230		350 – 500
	370		501 – 800

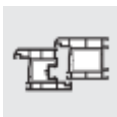

Description	Material	Page
window frame clearance PVC		7 - 3
rebate corner hinge PVC	TBFE1031, TBFE1032, TBFE1011, TBFE1012, TBFE1021, TBFE1022, TBFE1101, TBFE1102, FKFE0011, FKFE0012	7 - 4
corner hinge PVC Ø 6x12/12	TBEB6180, TKEB0020	7 - 6
corner hinge PVC	TBEB6130, TBEB6120, TKEB0020	7 - 7
corner hinge PVC ADV	TBEB6140, TBEB6150, TKEB0020	7 - 9
botom hinge PVC \2 3x3	FEBL0130, TBLB0010, FKEO0010, FKEU0010	7 - 11
botom hinge PVC \2 6x8	717691, TBLB0010, FKEO0010, FKEU0010	7 - 12
botom hinge PVC \2 6x12	FBEL0120, TBLB0010, FKEO0010, FKEU0010	7 - 13
botom hinge PVC \2 6x24/3	704592, TBLB0010, FKEO0010, FKEU0010	7 - 14
botom hinge PVC \2 3x3/3 FA	TBEL6150, FKEO0020, FKEU0010	7 - 15
stay hinge DH PVC	707470, 707432, 707449, 707586, 707456, 707494, 707500, FKWB0010	7 - 16
top hinge DH PVC Ø 3x3	FBSL0010, FBSB0010, FKSL0010	7 - 17
top hinge DH PVC Ø 6x8	717707, FBSB0010, FKSL0010	7 - 18
top hinge DH PVC Ø 6x12	FBSL0030, FBSB0010, FKSL0020	7 - 19
sash hinge PVC 12/..	707790, 707752, 704776, 704813, FKWB0010	7 - 20
tilt sash hinge PVC 12/..	704707, 704660, 704677, 704684, 704738, FKWB0010	7 - 21
window frame clearance timber 12 mm		7 - 22
rebate corner hinge H	TBFE8401, TBFE8402, TBFE8411, TBFE8412, TBFE8431, TBFE8432, TKFE7011, TKFE7012	7 - 23
rebate cor.hinge A0175 H	700273, 700396, 862780, 894019, 894026, 861929, FFDS0011, FFDS0012, FKFE0011, FKFE0012	7 - 25
botom hinge H-12/.	FBEL0010, FBEL0020, TBEL0010, 700617, 700624, FKEO0010, FKEU0010, FKEL0010	7 - 27